

eco-Air Series

# EVAPCO Controller User's Manual

AIR COOLED · ADIABATIC · FLUID COOLERS · CO<sub>2</sub> GAS COOLERS · REFRIGERANT CONDENSERS



For EVAPCO authorized parts and service, contact your local EVAPCO representative today!





## Table of Contents

<b>Introduction</b> .....	3
EVAPCO Controller .....	3
<b>Installation and Wiring</b> .....	3
Safety.....	3
Panel Installation Considerations .....	4
Temperature/Pressure Sensor Installation.....	4
Wiring Considerations.....	6
Operation and Servicing.....	6
<b>Screen Navigation</b> .....	7
Navigating the Display .....	7
Modifying a Value.....	8
Navigating the Scheduler .....	8
<b>Operator Interface Screens</b> .....	10
Welcome Screen .....	10
Home Screen.....	10
Status Screen .....	12
Alarms Screen.....	13
Main Menu Screen.....	15
On/Off Unit Screen .....	15
View Setpoints Screen.....	16
Scheduler Screens.....	17
Input/Output Screens .....	19
Service Screens .....	19
Manufacturer Screens .....	35
<b>Terminology</b> .....	36
<b>Alarm Event Description</b> .....	37

## Introduction

---

### EVAPCO Controller

Congratulations on the purchase of your eco-Air unit with the EVAPCO Controller. The EVAPCO Controller will ensure your eco-Air unit is operating in the most efficient manner possible while using minimal resources. Along with proper eco-Air unit maintenance, the EVAPCO Controller will ensure that your eco-Air unit provide years of service at peak efficiency.

The EVAPCO Controller serves as a single connection point for the eco-Air unit and contains all of the protection and logic devices required to run the eco-Air unit in the most efficient manner possible.

In order to reduce downtime, Evapco recommends keeping a stock of spare fuses. Consult the wiring diagram for the quantity, type, and fuse size required. Contact your local EVAPCO representative for replacement or spare parts.

This bulletin includes a description of the screens and parameters that are available through the display located on the front of the EVAPCO Controller. Also included in this bulletin are the functions of the EVAPCO Controller. Please note that the screens displayed on your EVAPCO Controller display may vary slightly from the images shown in this document.

Become familiar with the EVAPCO Controller by thoroughly reading and understanding the content of this bulletin. A detailed wiring diagram can be found in the data pocket inside of the EVAPCO Controller.

If you should require any additional information about the operation or maintenance of this equipment, contact your local EVAPCO representative. You may also visit [www.evapco.eu](http://www.evapco.eu) for more information.

## Installation and Wiring

---

### Safety

Qualified personnel should use proper care, procedures, and tools when operating, maintaining, or repairing this equipment or any other connected equipment in order to prevent personal injury and/or property damage. The warnings listed below are to be used as guidelines only.

**Warning: EVAPCO eco-Air units should never be operated without fan screens and access doors properly secured and in place.**

**Warning: Avoid working on electrical circuits while they are live. Proper lock-out/tag-out and all applicable safety practices must be followed prior to servicing any equipment.**

**Warning: Before opening the panel door, allow sufficient time for VFD's to discharge after removing power. VFD's contain capacitive circuits which maintain a charge even after power is removed.**

**Warning: The three-position selector switch is not intended to replace or act as a disconnect to disable the EVAPCO eco-Air unit and/or de-energize the EVAPCO Controller. Be sure to follow lock-out/tag-out and all applicable electrical safety practices before servicing any equipment.**

**Warning: Do not attempt to service or enter the eco-Air unit even if the unit status is indicated as being off. Unless power is completely removed from the eco-Air unit, it may be possible for the eco-Air unit to start at any time without notice. Be sure to follow lock-out/tag-out and all applicable electrical safety practices before servicing any equipment.**

The following safety issues need to be addressed by those responsible for the installation, maintenance, and repair of the EVAPCO Controller:

- Access to the control panel (including the disconnect switch(es)).
- Sizing and protection of electrical circuits feeding the control panel(s) and branch circuits feeding the controlled equipment.
- Proper grounding of electrical circuits.
- Qualification of persons who will install, maintain, and service the electrical equipment.

## Panel Installation Considerations

When the EVAPCO Controller does not ship factory mounted on the eco-Air unit, the EVAPCO Controller should be placed in close proximity to the eco-Air unit to reduce the wire lengths required. If the EVAPCO Controller is within sight of or mounted on the eco-Air unit, the EVAPCO Controller may be used as the main electrical disconnect for the eco-Air unit. Otherwise, separate electrical disconnects may be required. Consult applicable electrical codes to make this determination. Avoid mounting the EVAPCO Controller with a southern exposure. This will minimize the amount of solar heat gain the system will experience and will make it easier to view the operator interface.

## Temperature/Pressure Sensor Installation

EVAPCO eco-Air fluid coolers are supplied with a thermowell and a RTD temperature sensor. The thermowell and temperature sensor should be installed in the common return pipework of the eco-Air fluid cooler unit. Thermowells must be installed in the horizontal sections of the coil piping. A small amount of thermal paste should be added to the thermowell before the RTD sensor is inserted to ensure a more accurate fluid temperature measurement.

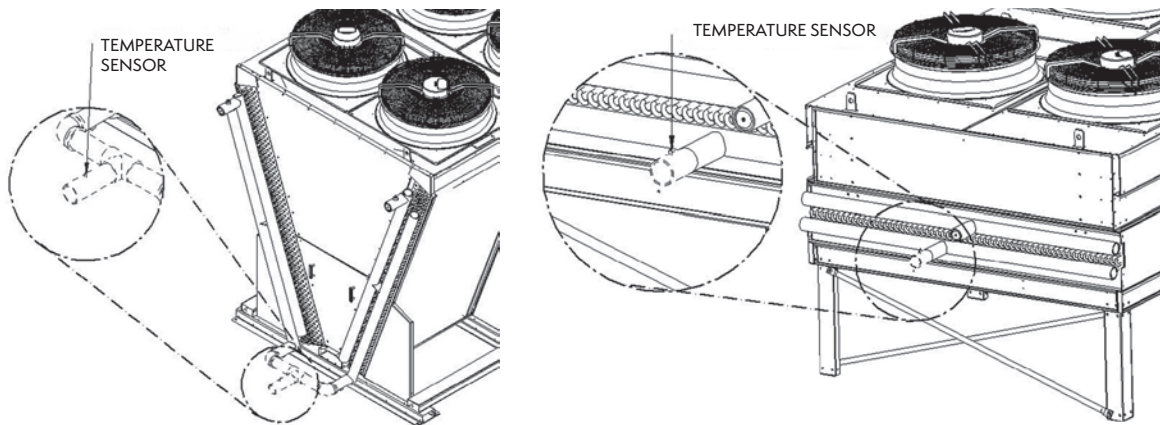

**Figure 1** - The suggested temperature sensor location for fluid coolers  
(Piping shown by dashed lines provided and installed by others)

EVAPCO eco-Air condensers are supplied with a pressure transducer (1/4" [25.4mm] NPT threads). The pressure transducer should be located in the common compressor hot gas discharge pipework. It is recommended that a shut-off valve be located between the pipe-work and the pressure transducer to allow the transducer to be more easily replaced should it become damaged.

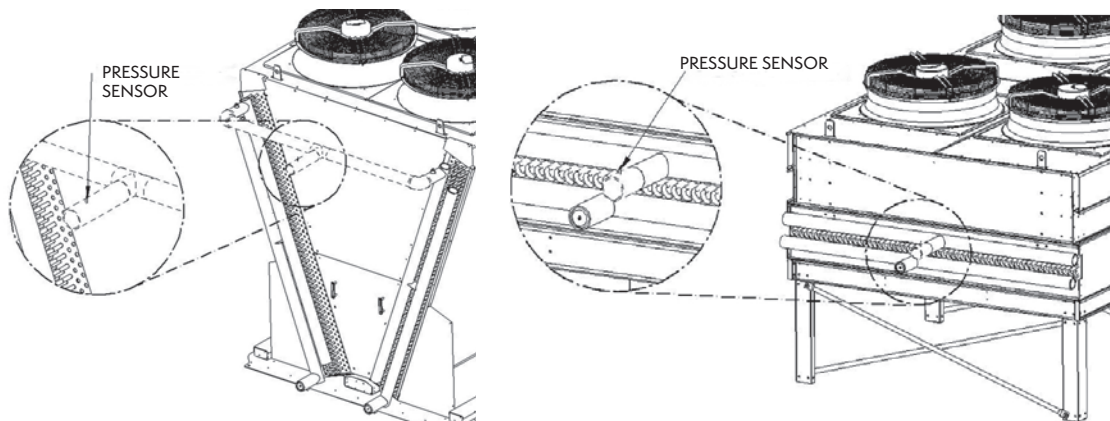

**Figure 2** - The suggested pressure sensor location for condensers  
(Piping shown by dashed lines provided and installed by others)

When the EVAPCO Controller ships factory mounted to the eco-Air unit, the supplied temperature or pressure sensor must be wired to the junction box location on the connection end of the eco-Air unit (Figure 3). If the EVAPCO Controller does not ship factory mounted, the supplied temperature or pressure sensor must be wired to the EVAPCO Controller. Consult the supplied wiring diagram for a determination if the junction box is supplied.

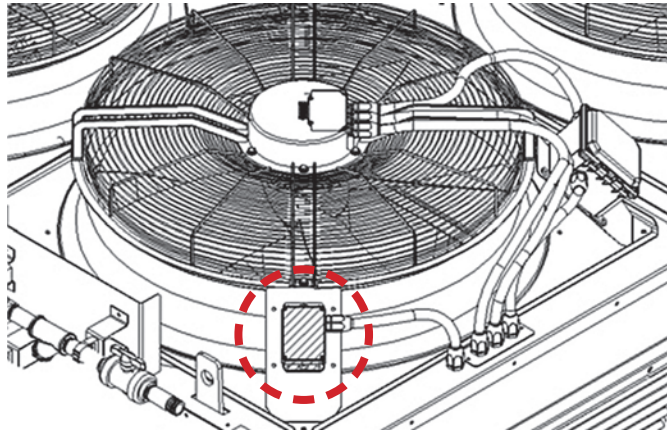

**Figure 3** - The junction box is highlighted and circled.

Each EVAPCO Controller is supplied with one ambient air sensor that is located near the Controller enclosure. Should the EVAPCO Controller not be factory mounted, the ambient temperature probe will need to be wired to the remote location of the Controller. Consult the supplied wiring diagram for proper termination of the ambient air sensor.

## Wiring Considerations

Consult the supplied wiring diagram for detailed wiring information. All field wiring is indicated by dashed lines on the wiring diagram.

All wiring in and out of the EVAPCO Controller should be with copper conductors and **wire lengths must be kept as short as possible**. Consult the detailed wiring diagram for field wiring connections of each device. Applicable electrical codes for the location should be followed during the sizing and installation of the field wiring. **All fittings attached to the EVAPCO Controller must be Type 4. All wiring must be through the bottom of the EVAPCO Controller. Top entry into the EVAPCO Controller is not permitted. Any damage caused to any component within or connected to the EVAPCO Controller due to a top entry connection is not warrantable!**

For wiring the EVAPCO Controller to each AC fan motor, Belden® VFD cable 295XX (XX denotes gauge) or equivalent should be used. The shield of the VFD cable needs to be bonded to ground at both ends of the cable.

While the EVAPCO Controller does provide provisions for connection to a BAS (Building Automation System), this connection is not required for the EVAPCO Controller to operate.

## Operation and Servicing

On eco-Air units equipped with AC fan motor(s), the EVAPCO Controller contains a three-position selector switch (Bypass-Off- Auto) located behind the HMI door. The operation of each position is as follows:

**Auto:** The **Auto** position allows the EVAPCO Controller to operate the eco-Air unit based on the logic programmed into the Controller. Note that the unit must be switched on before the eco-Air unit will begin to operate. Please see **the On/Off Unit Screen** section of this document for more information.

**Off:** In the **Off** position, the EVAPCO Controller will be powered; however, output commands will not be sent to any of the attached equipment. This position is used for programming the VFD.

**Bypass:** In the **Bypass** position, the logic program is bypassed which allows the fan motor(s) to energize independent of sensor temperature or setpoints. Power is routed around the VFD and thus the fan motor(s) will operate at full power, across-the-line. The VFD will still be energized when the selector switch is in the Bypass position.

The cover protecting the HMI must be shut unless an operator is using the HMI interface. This will protect the HMI interface from contamination and increase the life of the HMI.

The EVAPCO Controller is supplied with air filters that must be inspected monthly for cleanliness. Filters must be replaced when they appear dirty or at least every 90 days. It is recommended that filters be replaced prior to peak ambient conditions to ensure the highest level of cooling. Depending on the installation environment, more frequent inspection and/or replacement may be required. A dirty filter can cause the internal panel temperature to increase and may cause component failure. Permanently removing the filter will allow dirt and particulates to enter the enclosure and may cause premature failure.

Please consult the proper Operation and Maintenance Instructions for start-up and maintenance guides for the eco-Air unit attached to the EVAPCO Controller.



## Screen Navigation

### Navigating the Display

The operator interface contains a 7" touch screen LCD display that allows the user to navigate the various screens as well as view and modify several setpoints that affect the operation of the eco-Air unit.

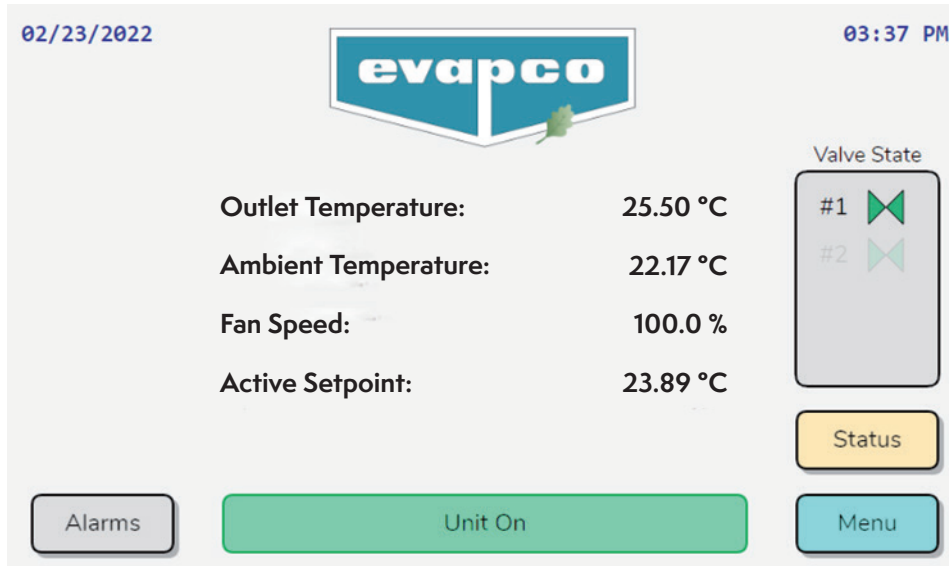

Figure 4 - The operator interface of the EVAPCO Controller.

Figure 5 provides an overview of the various screens and menus of the EVAPCO Controller. Pressing the Back button will return to the previous screen. The status button is only present for units equipped with either precooling or EC type fans.

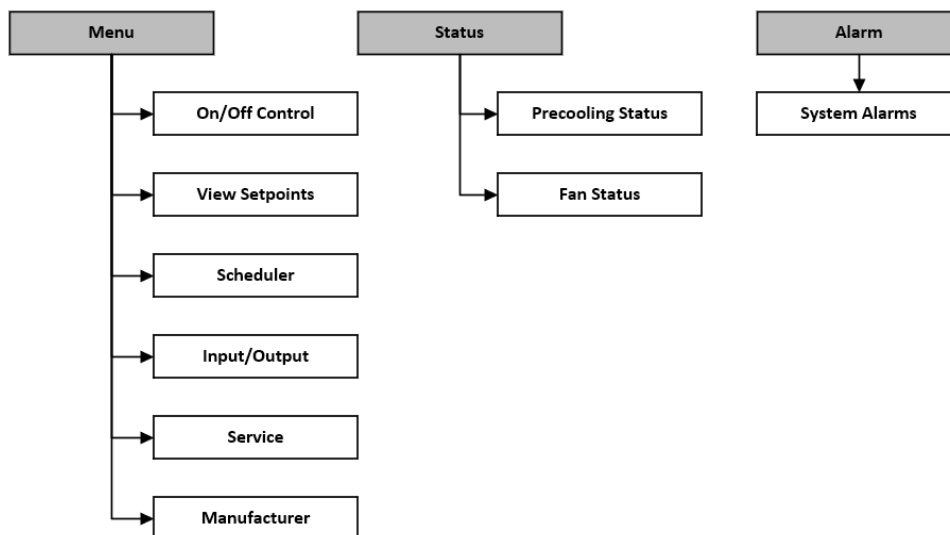

Figure 5 - Controller screen flowchart.

### Modifying a Value

To change a parameter on a given screen, first navigate to the desired screen. In this example, the setpoint temperature will be modified. Once at the desired screen, press the value associated with the parameter and enter the value in the number pad that appears.

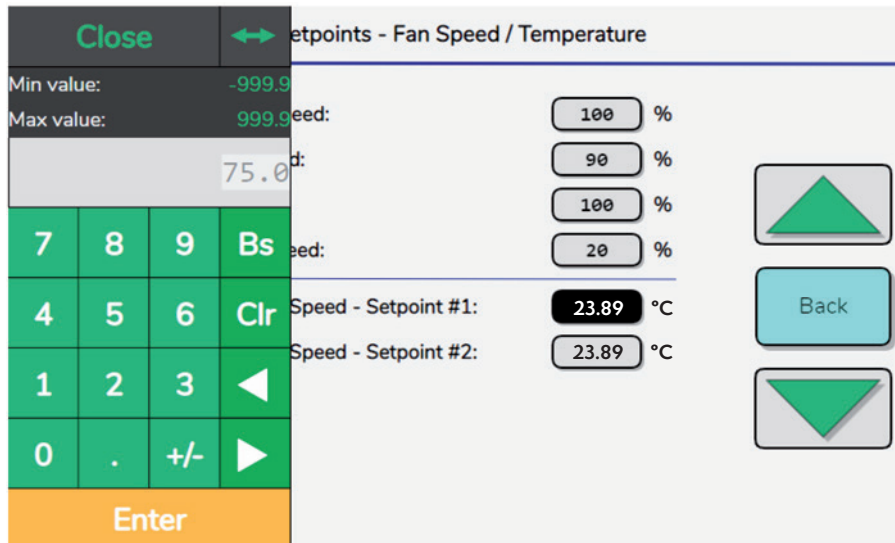

Figure 6 - The number pad to change a parameter for the setpoint temperature.

### Navigating the Scheduler

Several functions of the EVAPCO Controller can be scheduled to operate during certain periods of the year or at certain times of the day. In this example, consider a noise restriction from 8:00pm to 6:00am starting Friday night and ending Saturday morning. During the noise restriction hours, the fan speed will be limited via the Quiet Mode. After navigating to the proper scheduler, the screen shown in Figure 7 will be displayed.

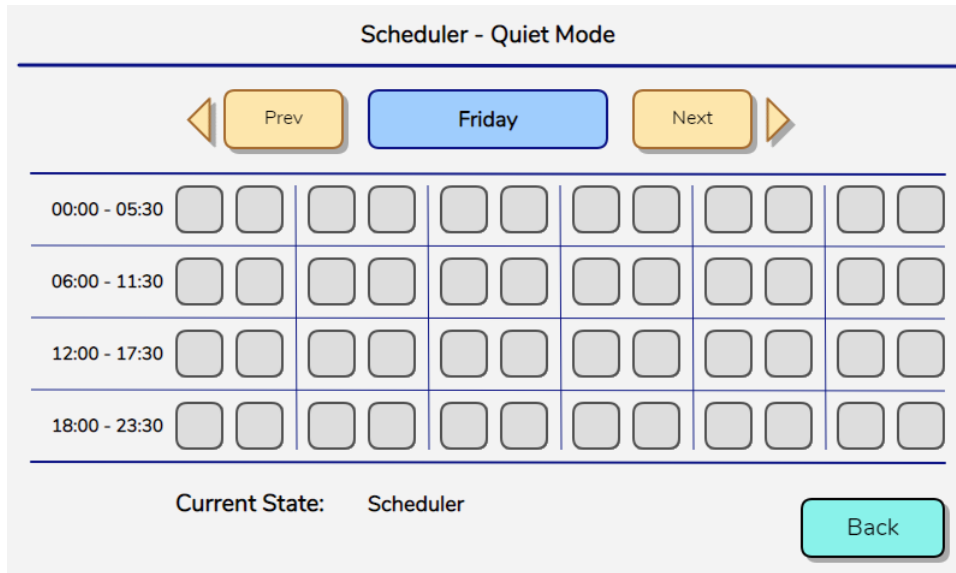

Figure 7 - The Scheduler Screen.



Each block represents a half hour increment of time. By touching a block, the ✓ icon will appear, and the function will be activated for that timeframe. Note that the first block represents 12:00am to 12:30am.

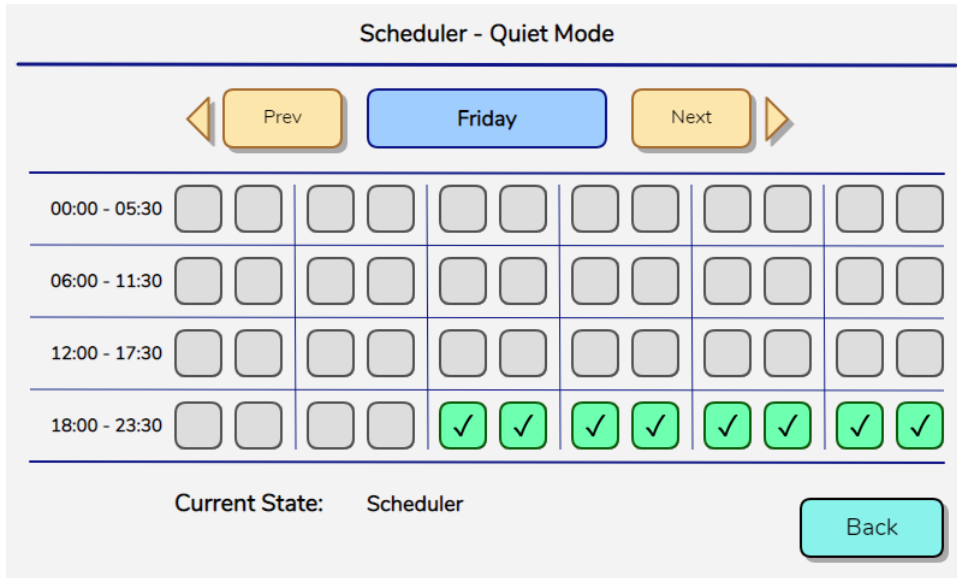

Figure 8 - The 8:00pm to 12:00am blocks are selected.

Proceed to Saturday by pressing the Next button. Continue to press the blocks to extend the timeframe to 6:00am.

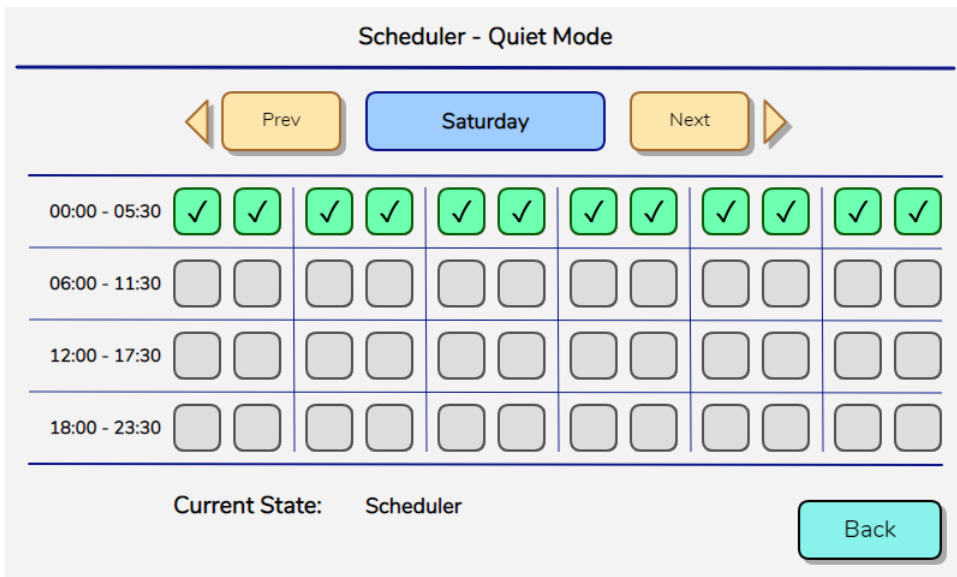

Figure 9 - Quiet Mode is active from 12:00am to 6:00am on Sunday.

## Operator Interface Screens

### Welcome Screen

When the EVAPCO Controller is first energized, the system will do a self-diagnostic test and load all the interface screens. While the screens are loading, the EVAPCO logo (Figure 10) appears. After the screens have loaded, the HMI will transition to the **Main Home Screen**. If there is no interaction with the HMI for more than fifteen minutes, the EVAPCO logo will reappear. Touching the HMI will return the screen to the **Main Home Screen**.



Figure 10 - The EVAPCO Controller Welcome Screen.

### Home Screen

The Main Home Screen shown in **Figure 11** displays the process temperature, ambient temperature, command fan speed, active setpoint, and the inlet pressure. The inlet pressure is only shown if the eco-Air unit is a condenser. Note, if the eco-Air unit is a condenser, the process temperature is the saturated condensing temperature derived from the temperature versus pressure relationship of the refrigerant (see the **Service Screens** section for more information).

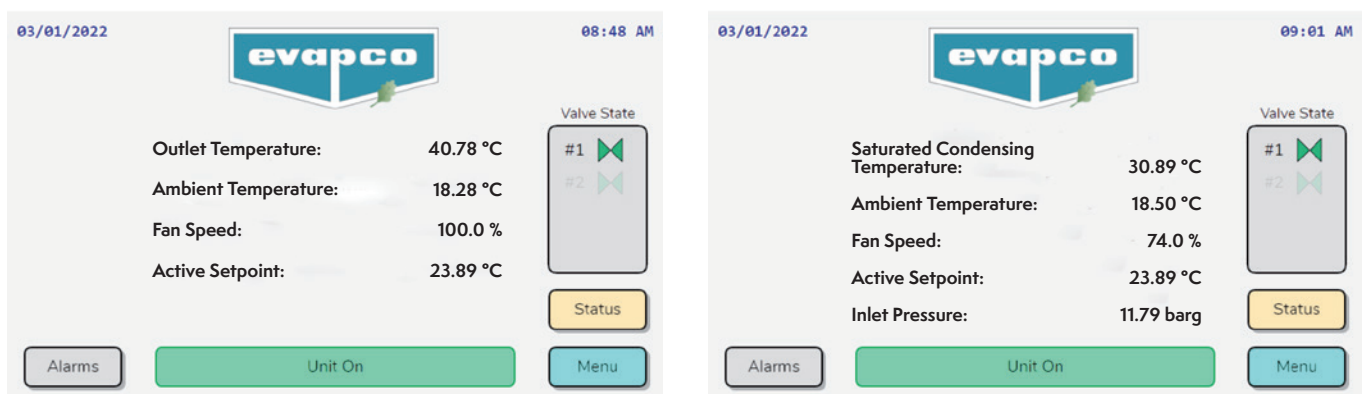



Figure 11 - The Main Home Screen.

If the eco-Air unit is equipped with a pre-cooling system, the status of the solenoid valves are shown at the right hand side of the screen as shown in Figure 11.

Image	Description
	Pre-cooling system is inactive (solenoid valve is closed).
	Pre-cooling system is active (solenoid valve is open).

**Table 1** - The states of the pre-cooling system status indicator.

While there is an active alarm, the Alarms button in the lower left corner of the main home screen (see Figure 12) will highlight. Press the **Alarms** button to go directly to the **System Alarms Screen**.

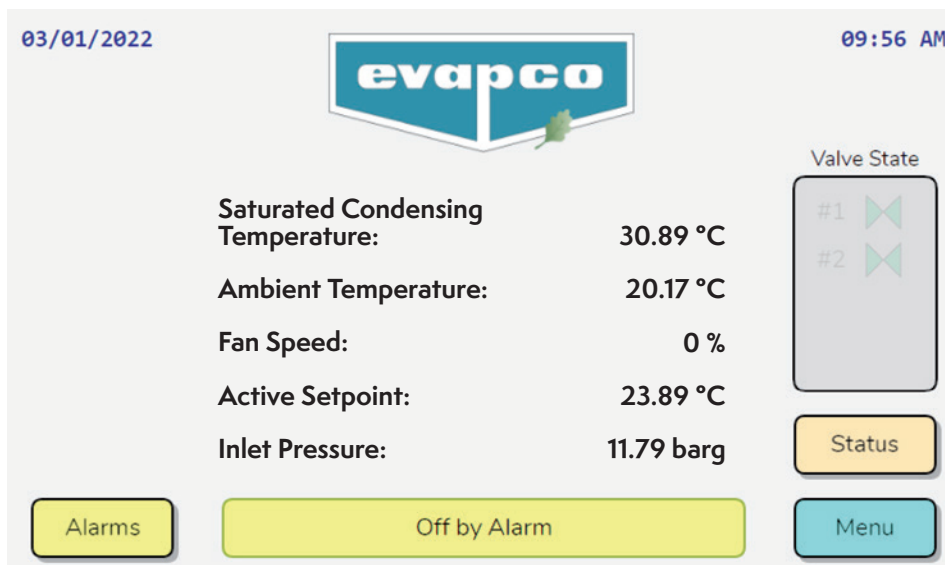

**Figure 12** - Main Home Screen with an active alarm.

### Status Screen

The **Status Screens** provide real time status of the solenoid valves and EC type fans. These status screens are only available with units equipped with precooling or EC type fans. Note that all values shown on the **Status Screens** are read only. To view additional status screens, press the Status button on the main home screen.

When the eco-Air unit is equipped with a precooling system, the Precooling Status screen will be present. The screen indicates the various timers associated with the control of the precooling system along with the rotation sequence of the solenoid valves.

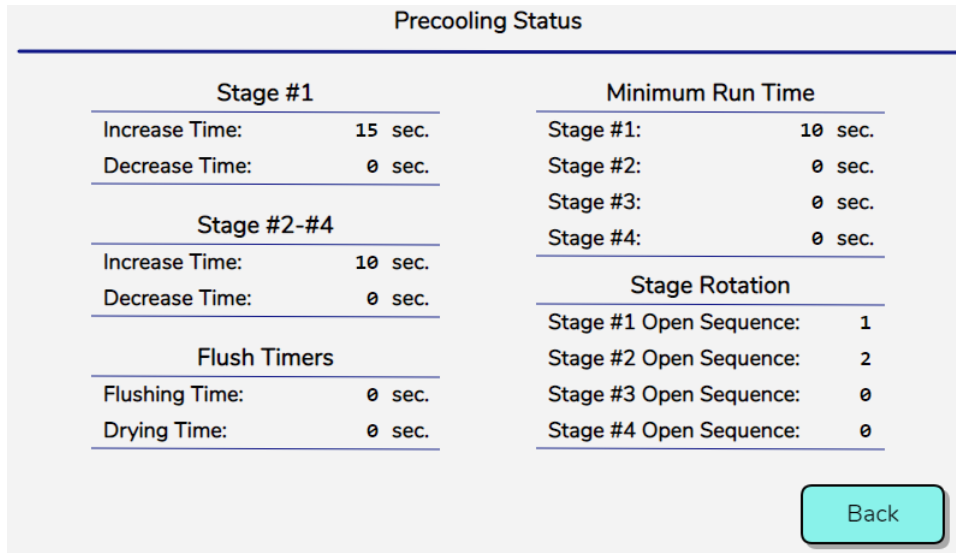

Figure 13 - The increment and decrement timers of the pre-cooling system.

In Figure 13, the Stage #1 and Stage #2-#4 incremental timers indicate if the precooling system is getting ready to activate (increase) or deactivate (decrease) based on the process temperature. If the process temperature rises past the active temperature setpoint and the fan speed reaches the current Energy Saving Fan Speed, the increase timer will begin to increment. Once the timer reaches a predetermined value, the precooling system will activate. Conversely, if the process temperature falls below the process setpoint while the precooling system is active, the decrease timer will begin to increment until a predetermined value is reached. Once the value is reached, the associated precooling solenoid valve will close.

If the minimum run time function is enabled, the precooling system remains active for a predetermined amount of time. The times shown in the Minimum Run Time section will begin to increment until it reaches a predetermined value. The precooling system will remain active until the minimum on time is satisfied.

When scheduled or manually enabled, the precooling system will undergo a flushing and drying sequence for a predetermined amount of time. Each cycle remains active until the timers shown in the Flush Timers section reach the appropriate duration.

When the precooling system contains multiple stages or solenoid valves, the solenoid or precooling section that enables first will rotate to balance the run time of the section. The stage will rotate whenever all the valves close. For example, if the eco-Air unit contains two stages, the first time the precooling system activates, stage one will be activated first followed by stage two. After both stages are switched off, the next time the precooling system is activated, stage two will be activated first followed by stage one.

When the eco-Air unit is equipped with EC fan motors, the status and current speed of the fan motors may be viewed. Depiction of the fans is not reflective of the arrangement of fans on the unit. Only the number of fans configured will be visible in the fan status screen. All additional fans will be hidden from view. The live fan motor speeds are in rpm.

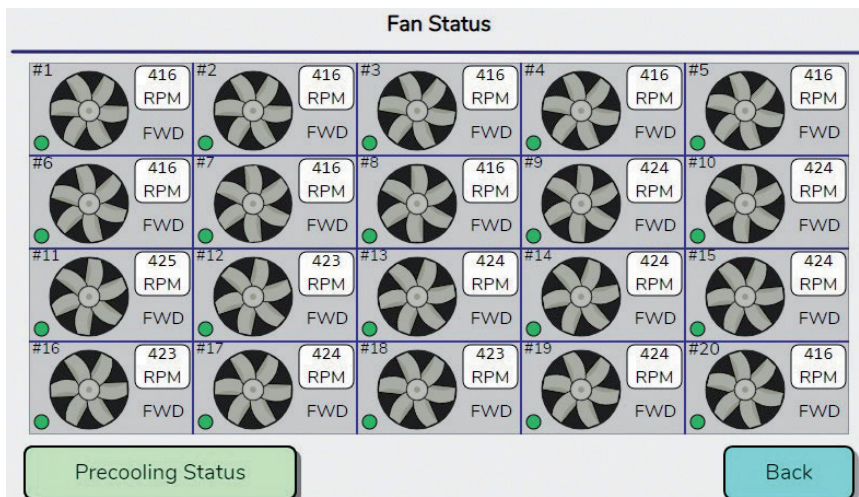

Figure 14 - Fan Status Screen

Image	Description
	<ol style="list-style-type: none"> <li>Each infographic tile represents a single fan assembly on the unit. The number of the fan is in the upper left-hand side of the tile.</li> <li>The current speed of the motor will be shown in RPM. There may be slight variation in values between individual motors.</li> <li>The fan graphic will rotate to provide visual feedback.</li> <li>The circle located in the lower left-hand side indicates the communication status between the PLC and the fan assembly. If the circle flashes between green and gray, the communication is online. If the circle is solid red, there is a loss of communication.</li> <li>(If Applicable) the current direction of fan rotation is shown.</li> </ol>

Table 2 - The states of the EC fan motor status indicator.

### Alarms Screen

The **System Alarms Screen** has two sets of logs for active alarms and history. By toggling the switch in the lower left-hand corner, the two different displays can be viewed. Only in the Active Alarms screen can alarms be acknowledged (Ack), while the clear history is reserved for the History Log. To scroll through either of the logs, touching the table will cause up and down arrows to appear.

There are two states shown in the Active Alarms log, active and acknowledged. When an alarm condition is returned, the message will be removed from the Active Alarms log. The Acknowledge button will change all active alarms from the Active state to Ack. This function is only meant to record the time at which an active alarm has been acknowledged. Refer to the **Alarm Event Description** for a description of the possible alarms.

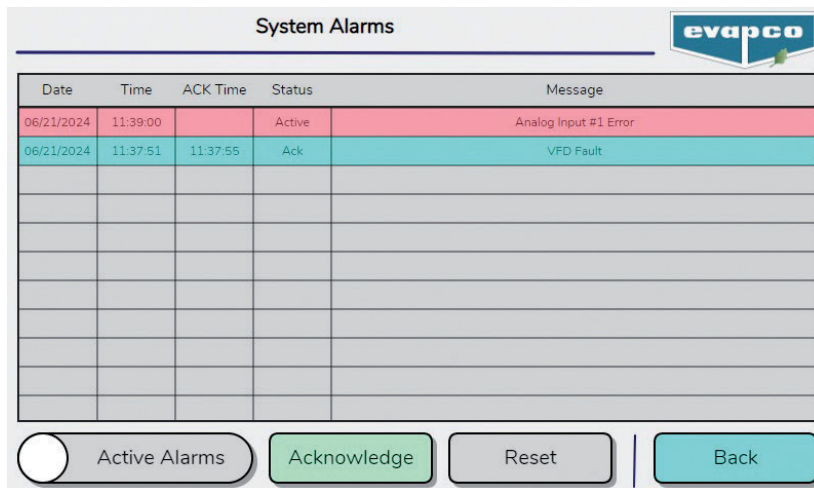

Figure 15 - The Alarms Screen.

The History Log view chronicles every alarm and each change in the status. Individual rows may be selected from the table to help illustrate a particular alarm. The Clear History button becomes visible in this view but requires a log in level of Service to unlock. Pressing the button for three seconds will delete all the alarm entries in the table. **Caution:** this action cannot be undone, and any alarms cleared will never reappear on the table unless a new instance of that alarm occurs afterwards. Pressing the Clear History button only deletes the entries in the History Log while any active alarms will remain in the Active Alarms screen.

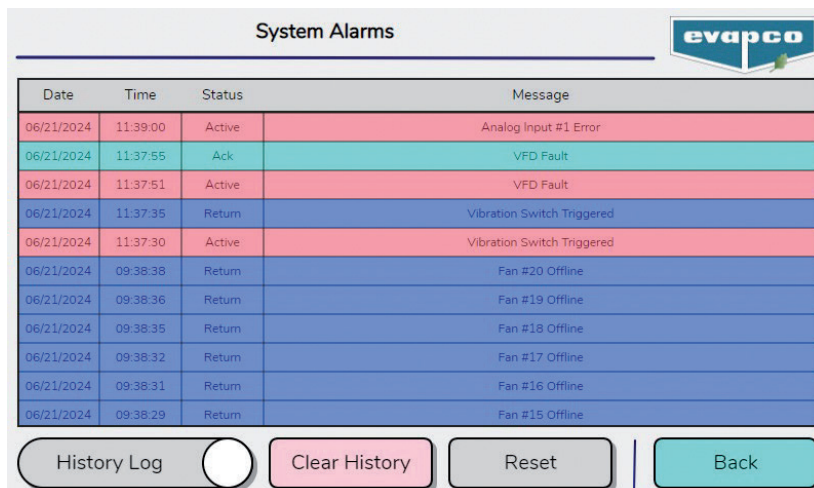

Figure 16 - The Alarms Screen with active alarm.

Alarms will appear in the logs as either Active, Ack, or Return. Table 3 illustrates each of the three states. The date and time columns of the table indicate when the alarm was triggered. In the Active Alarms screen, when an alarm is acknowledged the time stamp will be displayed in the ACK Time column.

Status	Screen	Image				
Active	Active Alarm	Date	Time	ACK Time	Status	Message
		06/21/2024	11:55:13		Active	Vibration Switch Triggered
	History Log	Date	Time	Status	Message	
		06/21/2024	11:55:13	Active	Vibration Switch Triggered	
	History Log (Selected)	Date	Time	Status	Message	
		06/21/2024	11:55:13	Active	Vibration Switch Triggered	
Ack	Active Alarm	Date	Time	ACK Time	Status	Message
		06/21/2024	11:55:13	11:55:47	Ack	Vibration Switch Triggered
	History Log	Date	Time	Status	Message	
		06/21/2024	11:55:47	Ack	Vibration Switch Triggered	
	History Log (Selected)	Date	Time	Status	Message	
		06/21/2024	11:55:47	Ack	Vibration Switch Triggered	
Return	History Log	Date	Time	Status	Message	
		06/21/2024	11:56:24	Return	Vibration Switch Triggered	
	History Log (Selected)	Date	Time	Status	Message	
		06/21/2024	11:56:24	Return	Vibration Switch Triggered	

Table 3 - The states of alarms.

Some alarms require a reset on the operator interface after the triggering condition has cleared. An example is the Vibration Switch Triggered alarm. When a vibration switch trips, the Reset button will be highlighted as shown in Figure 17. After the switch is reset on the unit, the Reset button must be pressed to clear the alarm.

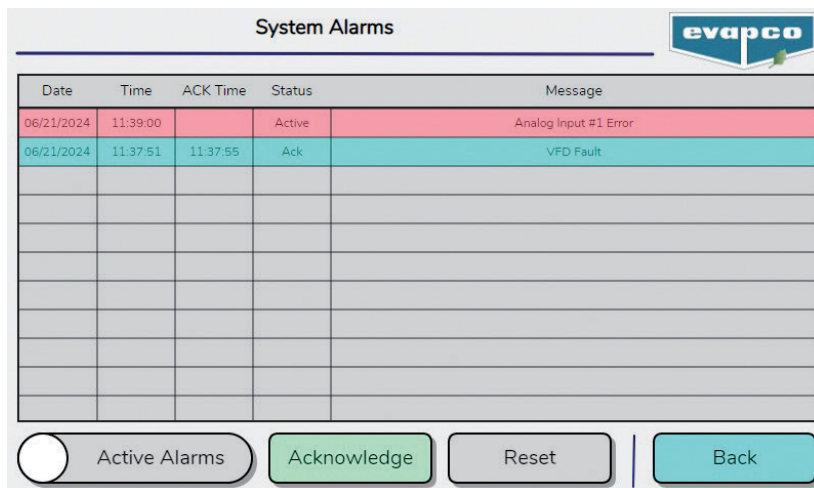

Figure 17 - The Alarms Screen with active alarm.

## Main Menu Screen

The **Main Menu Screen** is available by touching the **Menu** button on the operator interface. The **Main Menu Screen** is used to navigate to additional screens that allow users to modify the current operation of the system or to view additional monitoring information.

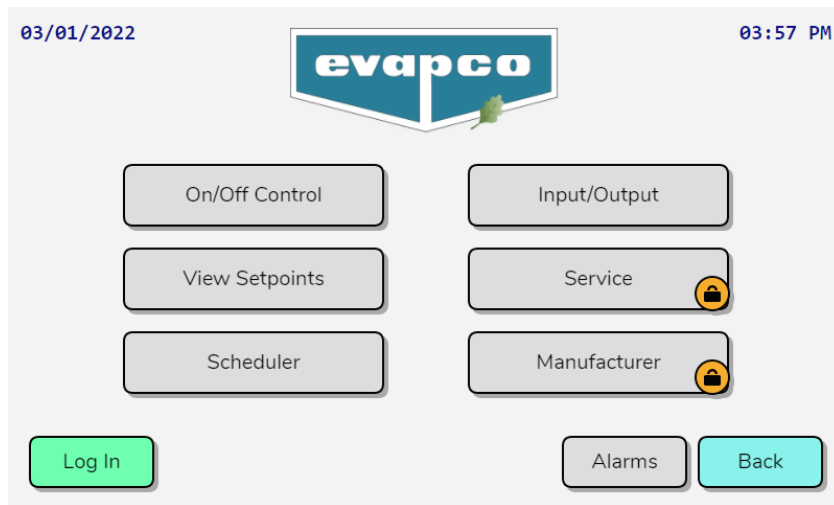

Figure 18 - The Main Menu Screen

## On/Off Unit Screen

The **On/Off Control** screen shows and allows the operator to set the current operational status of the eco-Air unit. When the eco-Air unit is not controlled via an external source (i.e. BAS), the **On/Off Control** screen is the only way to disable the eco-Air unit without removing power. Note that the EVAPCO Controller must be switched on locally before the unit will operate even if the EVAPCO Controller is being controlled via a BAS or digital input.

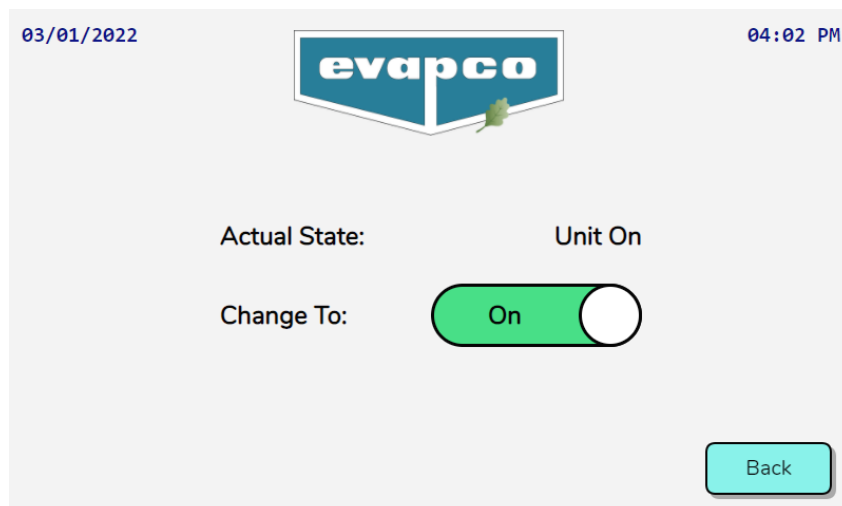

Figure 19 - The On/Off Unit Screen

The various operational states of the eco-Air unit are explained in the following table:

Status	Description
Unit On	Unit is operational.
Off by BMS	Unit is being controlled via a BAS and may be enabled by sending an enable signal to the EVAPCO Controller.
Off by Digital Input	Unit is being controlled via a digital input and may be enabled by sending an enable signal to the EVAPCO Controller.
Off by HMI	Unit is turned off manually and may only be enabled via the On/Off Control Screen.
Off by Alarm	The unit has been turned off due to an alarm.

Table 4 - Unit Operational States

### View Setpoints Screen

The **View Setpoints Screen** allows viewing of all setpoint parameters. For a detailed description of the setpoints and instructions on how to change the various setpoints and options, please see the **Service Screens** section of this document.

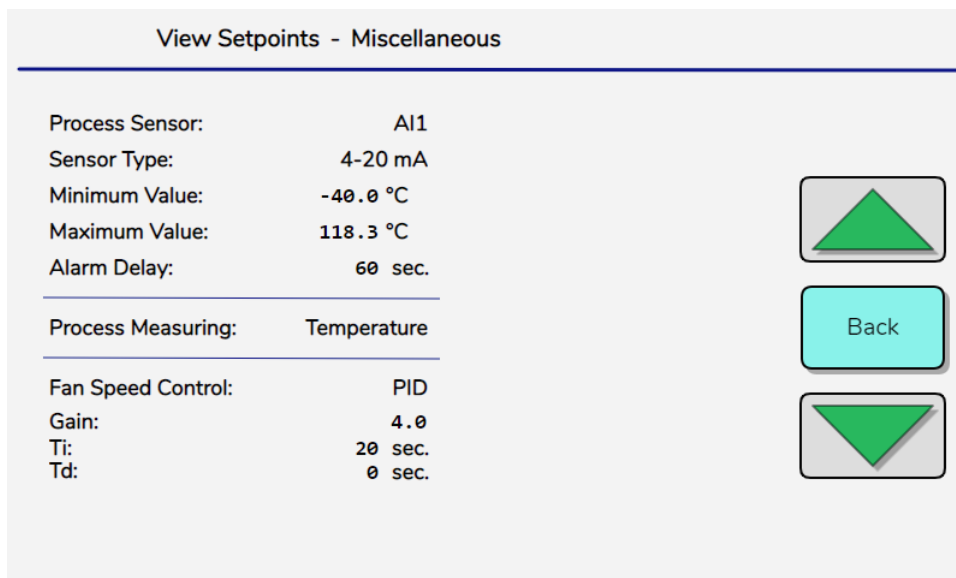

Figure 20 - Viewing Setpoints



## Scheduler Screens

The **Scheduler Screens** allows the internal clock of the EVAPCO Controller to be set as well as the scheduling of several routines. If enabled, the following routines may be programmed during certain periods of certain days:

Routine	Function	Example Use
Quiet Mode	Limits the maximum fan speed to the value set for quiet operation.	There is noise restriction during nighttime periods due to close proximity of residences.
Setpoint #2	Switches the active setpoint to an alternate value.	The cooling load is for an office building which does not require as much cooling during off hours.
Daily Flush	The pre-cooling system is activated to run water over the adiabatic pads.	The unit installation site is located next to a field. The flush routine runs at night to rinse any debris that may have been sucked onto the adiabatic pads during unit operation.

**Table 5** - Scheduler Functions

For instruction on setting the scheduler, please see the **Navigating the Schedule** section of this document. Note that unless the desired routine is set to run via the scheduler (except the flush routine), the scheduler will not operate as selected.

If equipped with a precooling system, the precooling system may be set to run only during certain dates. In climates that are subject to freezing temperatures or if there is a reduced cooling load during certain periods of the year, the scheduler may be used to disable the precooling system. **Note that all pipework that is susceptible to freezing must be heat traced to avoid damage.** When the scheduler is enabled, the precooling system will only operate during the dates shown in the screen. When in the *Enabled* state, the precooling system will activate when required as long as all conditions (e.g. enabled for scheduler, ambient is above lower limit, etc.) are satisfied. When changed to *Disabled*, the precooling system will not activate even if additional cooling is required.

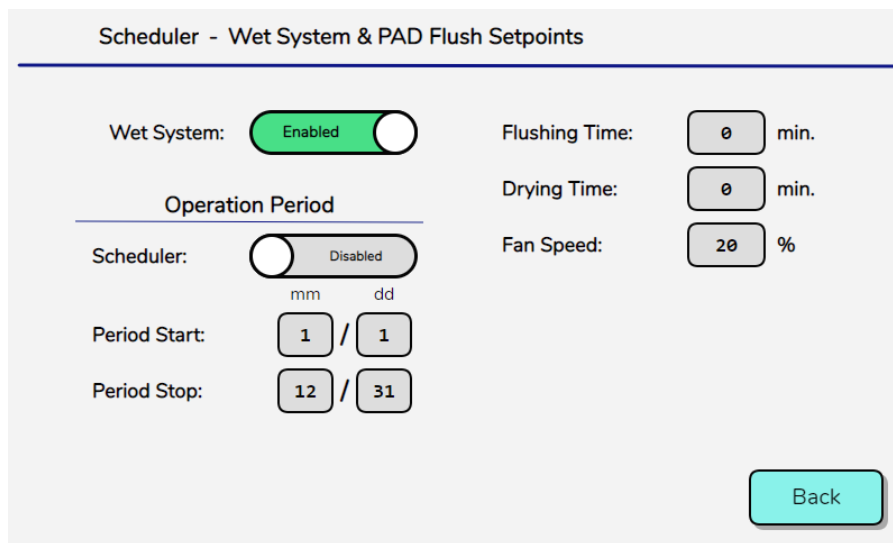

**Figure 21** - Pre-cooling System Scheduler

Parameter	Description	Default
Flushing Time	The amount of time that water flows over the adiabatic pads.	0 minutes
Drying Time	The amount of time that the fans run in reverse (EC Type Only) during the flushing routine.	0 minutes
Fan Speed	The fan speed (reverse) during the dry cycle of the flushing routine.	0%

**Table 6** - Flushing Routine Parameters

The internal clock of the EVAPCO Controller may be set in the screen shown in Figure 22. If any of the scheduler functionality of the EVAPCO Controller is used, it is vital that the clock be set to the proper time. The clock is used to add timestamps to the alarms shown in the **System Alarms** screen. To adjust the time, the New Date:, Day of Week:, and New Time: must all reflect the desired date/time. After entering the information press the Update button.

**Scheduler - Clock Adjust & DST**

Current Date: 03/10/2022      Current Time: 02:02:31 PM

New Date: mm dd yy      New Time: hh mm ss

Day of Week: Sunday ▼      Update

Daylight Saving: Disabled ▼

Daylight Saving options: Disabled, Europe, US/Canada

Back

**Figure 22** - The Clock Adjustment Screen.

Daylight savings can be enabled in the screen shown in Figure 22. Table 7 gives a description of the functionality based on the zone that is selected.

Zone	Description
Disabled	Daylight saving functionality is disabled
Europe	Daylight saving functionality will start on last Sunday of March at 1:00 a.m. DST and end on last Sunday of October at 2:00 a.m.
US/Canada	Daylight saving functionality will start on second Sunday of March at 2:00 a.m. local time and end on first Sunday of November at 3:00 a.m.

**Table 7** - Daylight Savings Parameter Screen

## Input/Output Screens

Figure 23 displays the current state of all digital inputs, digital outputs, analog inputs, and analog outputs of the EVAPCO Controller. This screen is primarily used for troubleshooting and start-up purposes to determine if the correct signals are being sent to and from the EVAPCO Controller.

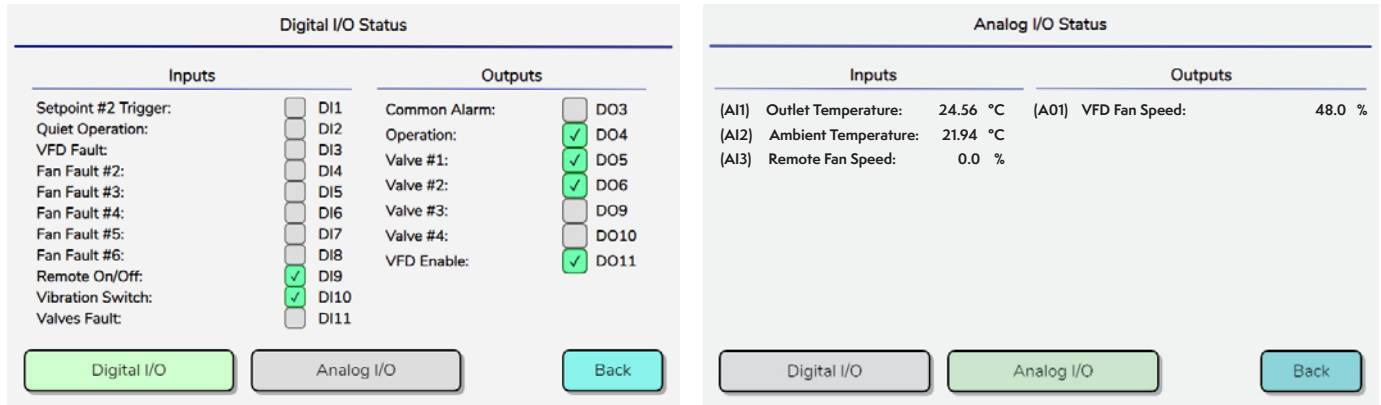

Figure 23 - Digital and Analog I/O Status Screens

## Service Screens

The **Service Screens** allow the user to change setpoints, timers, and other parameters that affect the operation of the eco-Air unit. The Service menu is inaccessible until logging in. Figures 24 illustrate the steps that need to be taken to unlock the Service button. The password for the Service level log in is 1234. If an incorrect password is entered, the screen will show Invalid Password.

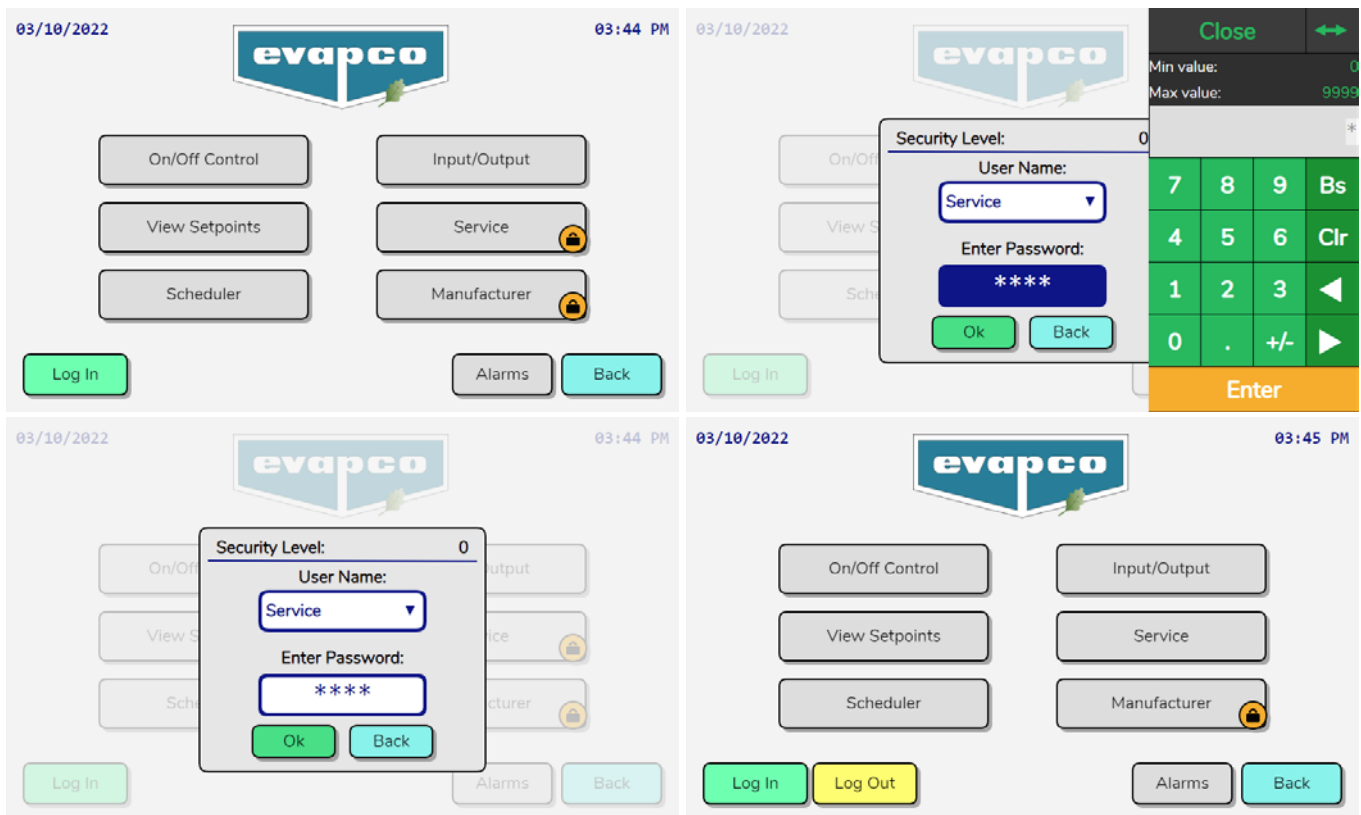

Figure 24 - Service Level Log In

After logging in and pressing the Service button, the screen will display the service submenu options as shown in Figure 25. If the unit is enabled the options for I/O Test and BMS & Network will not be available. Turn the unit off to enable these options, as shown in Figure 26.

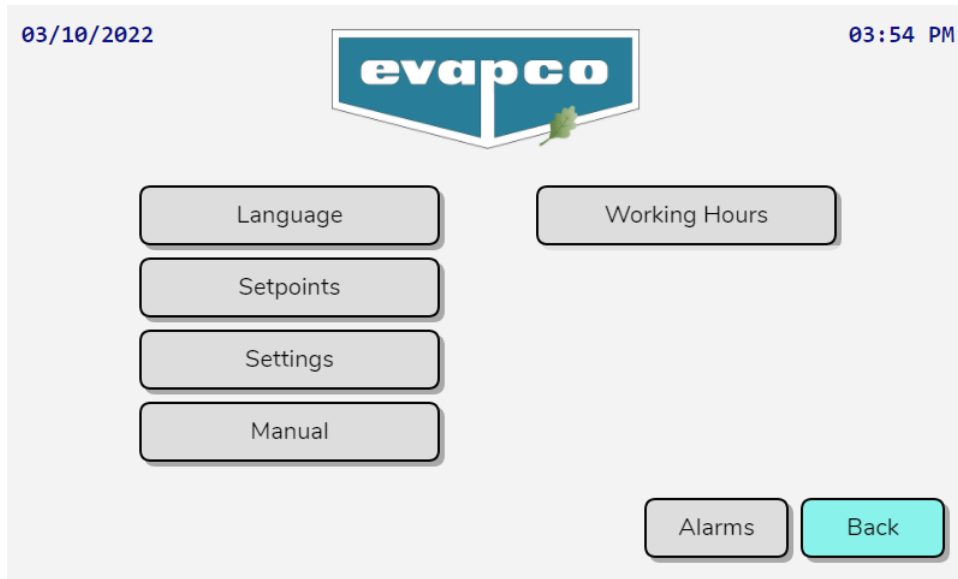

Figure 25 - Service Submenu

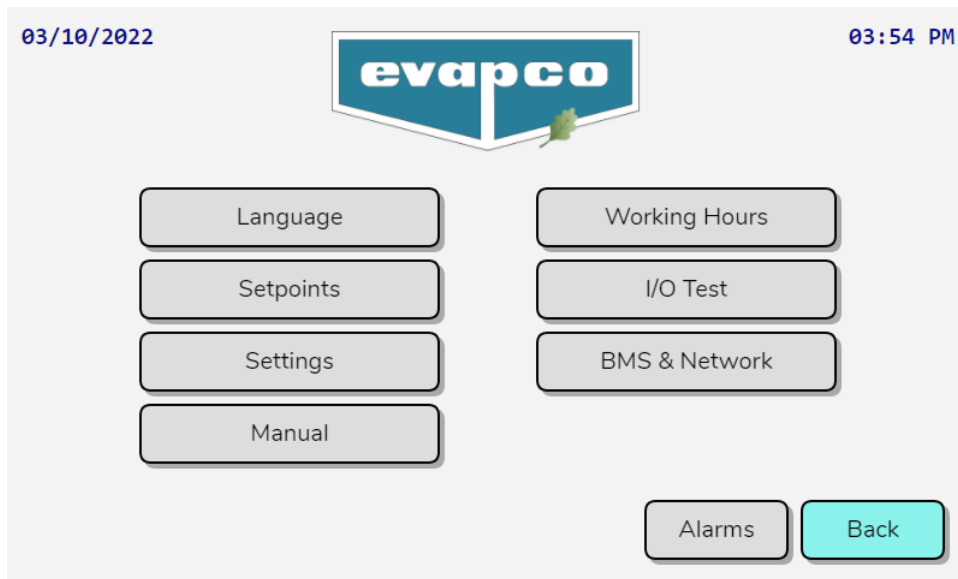

Figure 26 - Service Submenu with Unit Turned Off

Pressing the Language button will change the screen to the one shown in image 27. The language drop down will allow the user to select between a preset number of available languages. The language selection at startup option can be enabled and disabled. This will prevent the Language screen from being the first screen that is displayed after the controller boots up. Also located on this screen is the current version of the HMI and PLC applications.

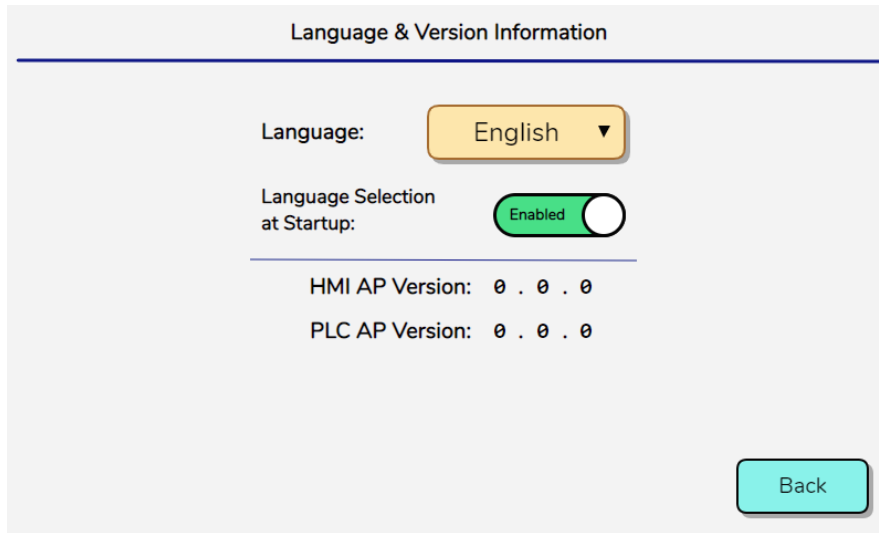

Figure 27 - Changing Language

Selecting Setpoints displays a series of screens that allow various setpoints and options that directly affect the operation of the eco-Air unit to be adjusted. The screen shown in Figure 28 allows the process sensor to be changed. Note that the proper sensor settings will be set at the factory and should not require modification.

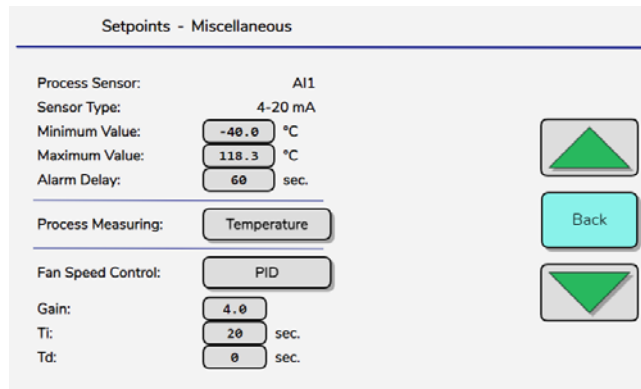

Figure 28 - Language Screen Parameters

Parameter	Description	Default
Minimum Value	The process value of the lower reading used to establish a scale.	Various
Maximum Value	The process value of the upper reading used to establish a scale.	Various
Alarm Delay	The amount of time that is allowed to elapse after the connection to the sensor is lost before an alarm is generated.	60 seconds

Table 8 - Process Sensor Parameters

The process measuring can be set to either Temperature or Pressure. Temperature process measuring is used for fluid coolers while the pressure process measuring is for condensers. Upon selecting Pressure, a drop down will appear with a list of predetermined refrigerants. Refer to Table 9 for a list of the available refrigerants. Note that this setting will be set at the factory and should not require modification.

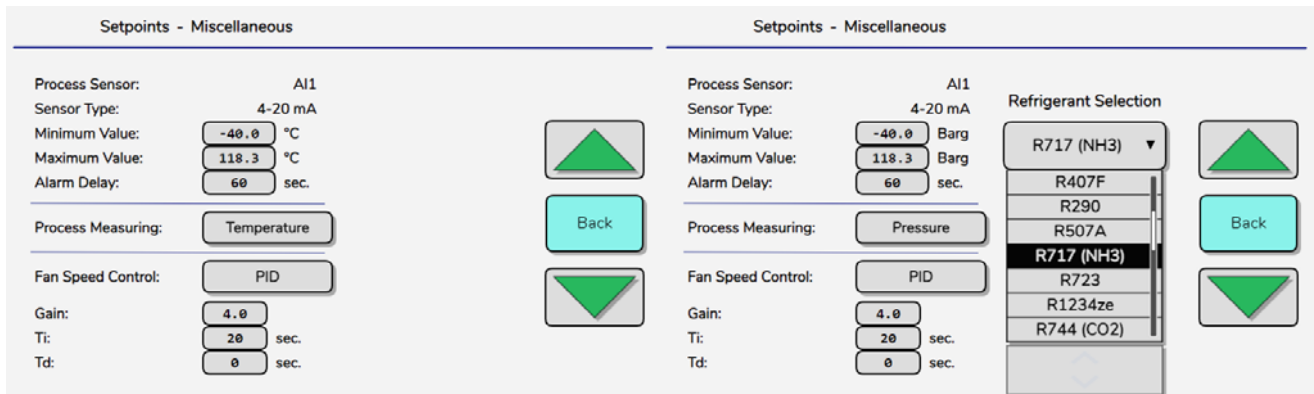

Figure 29 - Process Measuring Set to Temperature for Fluid Coolers and Pressure for Condensers

Preprogrammed Refrigerants			
R22	R134a	R404A	R407C
R410A	R407A	R407F	R290
R507A	R717 (NH3)	R723	R1234ze
R744 (CO2)	R448A	R427A	R450A (N13)
R513A	R449A	R1234yf	R454B
R454C	R455A	R434A	R422A
R32	R452B	R452A	Custom

Table 9 - Preprogrammed Refrigerants

If a refrigerant is required that is not available for selection in Table 9, Custom should be selected in the drop down. This will expose a new screen that gives ten data points to enter saturated temperature and pressure values characteristic of the refrigerant in use. The data points will create a piece-wise graph that the EVAPCO controller will use to linear interpolate the saturated condensing temperature based on the input pressure reading. Reference Figure 30 as an example of the information needed to fill in the table.

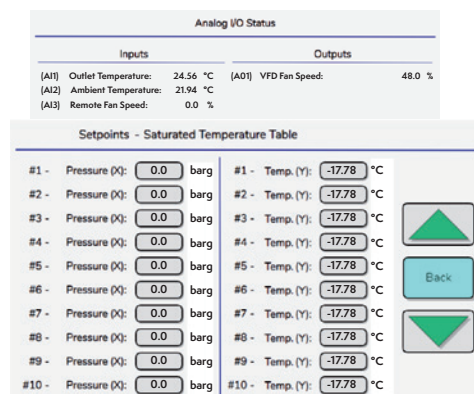

Figure 30 - Custom Refrigerant Properties

The EVAPCO Controller provides two methods of automatic setpoint control. When the Fan Speed Control: is set to PID, the fan speed will be adjusted based on the deviation of the process temperature to the desired setpoint by a PID regulator. Note that there are several factors that may influence the behavior of a PID controller, and the proper tuning parameters may vary from the factory defaults. PID regulation is the recommended method of control for the EVAPCO Controller.

When the Fan Speed Control: is set to Proportional, the fan speed will be scaled linearly based on the desired setpoint and a differential band parameter.

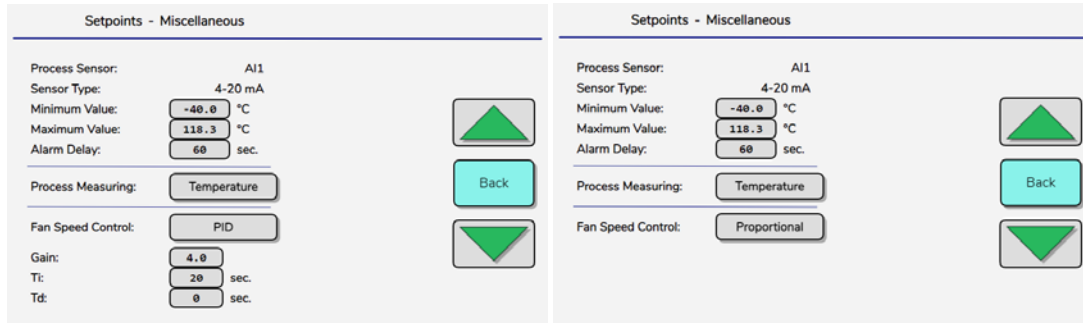

Figure 31 - Proportional or PID Fan Speed Control Setting

Parameter	Description
Proportional	Controls the fan speed by subtracting the process temperature from the setpoint temperature and linearly ramping up the fan speed to the current maximum value.
PID (Default)	Controls the fan speed by utilizing a feedback compensator consisting of a proportional, integral, and derivative value.

Table 10 - Fan Speed Control Options

Parameter	Description	Default
Gain	The proportional term of the PID.	4
Ti	The integral term of the PID.	20
Td	The derivative term of the PID.	0

Table 11 - PID Fan Speed Control Parameters

The Fan Speed/Temperature Screen shown in Figure 31 determines the various speeds at which the eco-Air unit runs in various modes. Note that the fan speeds are set in percentage of the fan motor's nameplate speed. The energy saving speed is not active unless the eco-Air unit is equipped with a precooling system. The energy saving fan speed allows the precooling system to activate one the fan speed reaches the energy saving value. Once the precooling system is activated, the fan motors will continue to increase in speed if the active setpoint is not met. The speed will continue to increase until the maximum allowed fan speed is met. To disable the energy saving functionality, set the energy saving fan speed to the maximum allowed fan speed.

The quiet operation fan speed limits the speed of the fan motors whenever the Quiet Mode is activated. Quiet Mode may be activated via the scheduler or a digital input. If the quiet mode fan speed is less than the energy saving fan speed, the precooling system will be prevented from operating. When cooling is not required and the fan speed settles to the minimum allowed fan speed, the fans will turn off based on the shutoff timer and offset. See Figure 7 for setup information.

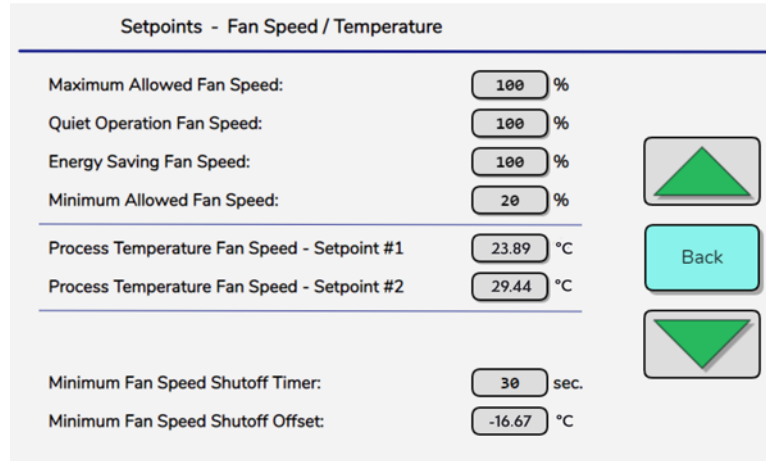

Figure 32 - P Fan Speed Control Parameters

Parameter	Description	Default
Max. Allowed	The maximum speed that the fan motors will reach when Quiet Mode is not active.	100%
Quiet Operation	The maximum fan motor speed allowed when Quiet Mode is activated via the scheduler or digital input.	100%
Energy Saving	The fan speed at which the pre-cooling system will activate.	100%
Min. Allowed	The minimum speed at which the fan motors will spin.	20% (AC Motors) 10%(EC Type Fans)
Min Shutoff Timer	The amount of time that must elapse whenever the fan speed reaches the minimum allowed percentage before the fans are turned off.	30 seconds
Min. Shutoff Offset	The temperature offset below the setpoint before the fans are turned off.	-16.67 °C

Table 12 - Fan Speeds Screen Parameters

The EVAPCO Controller is equipped with two process temperature setpoints. Setpoint #1 is for normal operation while Setpoint #2 can be initiated either through the scheduler, digital input, or based on ambient temperature conditions. When the fan speed control is set to Proportional, the additional Temperature Proportional Band parameter is made available.

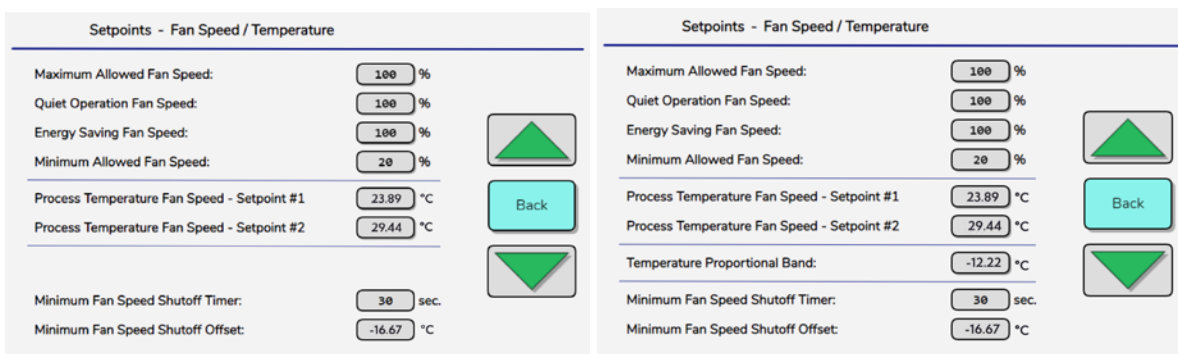

Figure 33 - The P Regulator Parameters Screen



Parameter	Description	Default
Process Temperature Fan Speed – Setpoint #1	The primary process setpoint.	Set According to Specification
Process Temperature Fan Speed – Setpoint #2	The secondary process setpoint that may be activated via the scheduler, ambient temperature, or digital input.	-
Temperature Proportional Band	Determines the temperature band between the minimum and maximum fan speed.	-12.22 °C

**Table 13 - P Fan Speed Control Parameters**

The value of the temperature proportional band will determine how quickly the fan motors will react to changes of the process temperature. For example, consider the following values. As shown in Graph 1, if the process temperature would be 25.28 °C, the command fan speed would be 50%. However, if the proportional band is set to -12.22 °C and the process temperature is 25.28 °C, the command fan speed would be 25%. A smaller temperature proportional band will result in rapid changes in the fan speed while a larger proportional band will result in more gradual changes in fan speed.

Parameter	Value
Setpoint 1	23.89 °C
Temperature Proportional Band	-15.0 °C
Minimum Fan Speed	0%
Maximum Fan Speed	100%

**Table 14 - Example of P Regulator Parameters**

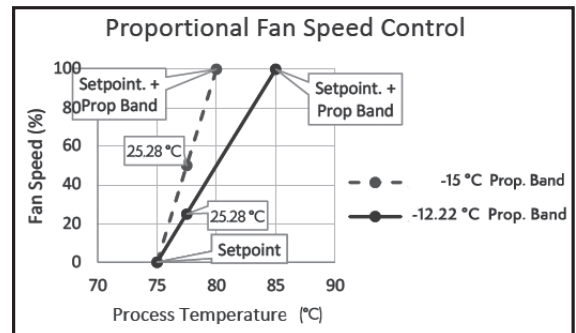

**Graph 1 - Temperature Regulation Band Samples**

If equipped with a precooling system, the screen shown in Figure 34 will be accessible. The parameters contained in this screen are used to determine various temperature setpoints that will activate the precooling system, along with timers to ensure hysteresis protection of the system.

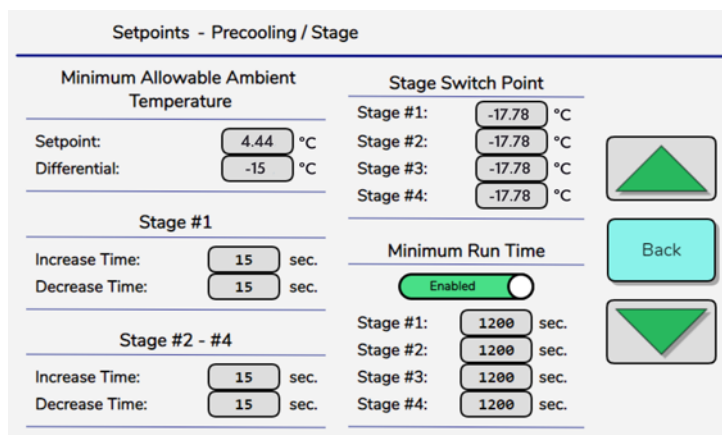

**Figure 34 - Pre-Cooling System Parameters**

To help prevent the precooling system from freezing, a minimum ambient operating temperature must be satisfied for the precooling system to be active. If the ambient temperature falls below the minimum specified temperature, the precooling system will deactivate and will not become active again until the ambient temperature rises above the minimum specified temperature plus the specified difference. For example, using the values shown in Figure 33, if the precooling system is operating and the ambient temperature falls below 4.44 °C, the precooling system will turn off and will not activate again until the ambient temperature reaches 7.22 °C. **Note that all pipework that is susceptible to freezing must be heat traced in order to avoid damage.**

Parameter	Description	Default
Setpoint	The minimum temperature at which the precooling system may operate.	4.44 °C
Differential	Determines the ambient temperature above the minimum allowable temperature setpoint at which the precooling system may activate.	-15 °C

**Table 15 - Pre-Cooling System Minimum Operating Ambient Temperatures**

In order to prevent minor fluctuations in the process temperature from quickly cycling the precooling system on and off, an increase and decrease timer is used. For example, using the values shown in Figure 33 and assuming a process setpoint temperature of 23.89 °C, the process temperature must remain above 23.89 °C for 15 seconds before the precooling system will activate. Conversely, if the precooling system is active, the process temperature must remain below 23.89 °C for 15 seconds before the precooling system deactivates.

Parameter	Description	Default
Stage #1 Increase Time	The amount of time that the process temperature must remain above the process setpoint before the first precooling stage activates.	15 seconds
Stage #1 Decrease Time	The amount of time after the preceding stages have disabled that the process temperature must remain below the process setpoint before the first precooling stage deactivates.	15 seconds
Stage #2-#4 Increase Time	The amount of time after the previous stage has enabled that the process temperature must remain above the process setpoint before the precooling stage activates.	15 seconds (pads) 60 seconds (spray)
Stage #2-#4 Decrease Time	The amount of time that the process temperature must remain below the process setpoint before the precooling stage deactivates.	15 seconds

**Table 16 - Increase and Decrease Timer Parameters**

The temperature switch points set a minimum temperature at which the precooling system stages may become active. **Note that this setting is not used for freeze protection but is instead intended to prevent the precooling system from operating during periods of the year when evaporative cooling is not required.**

Parameter	Description	Default
Stage 1-4	The minimum temperature above which the associated stage of the precooling system may activate.	-17.78 °C

**Table 17 - Stage Switch Points**

Due to the orientation and low water usage of precooling systems equipped with adiabatic pads, it may take several minutes for the precooling system to become fully effective. To prevent the precooling system from cycling during short periods of time, a minimum run time for the precooling system may be set. Once enabled, the precooling system will remain on until the minimum run time for the applicable stage is satisfied.

Parameter	Description	Default
Enable Stage On Time	Enables or disables the stage minimum on timers. <b>Note for spray systems, the parameter should be disabled or lower the duration of the minimum on timers.</b>	Enabled
Stage 1-4	The minimum amount of time that the precooling stage remains on once activated.	1200 seconds

Table 18 - Pre-Cooling Stage On Time Parameters

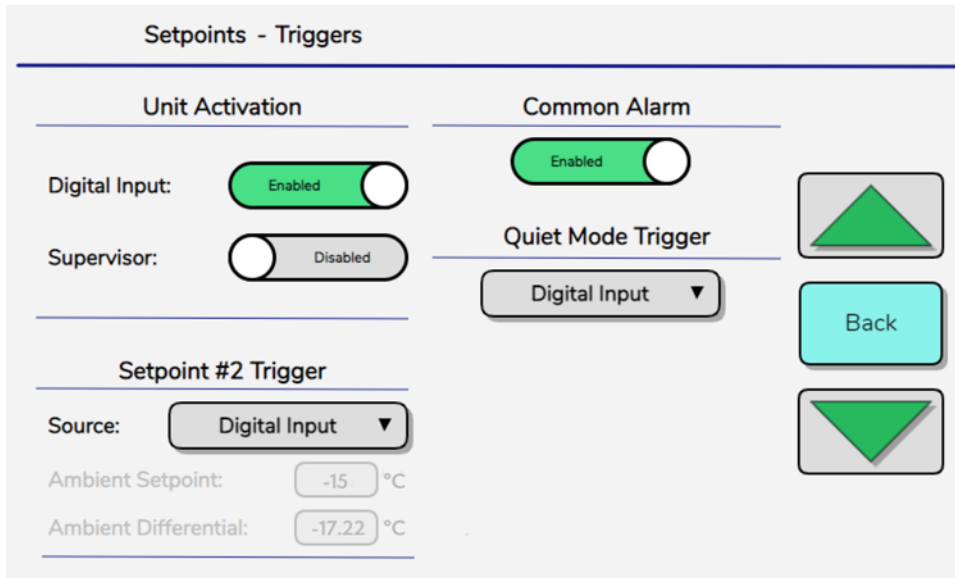

Figure 35 - Various Modes of Operation Triggers

The EVAPCO Controller may be configured to activate the attached eco-Air unit in several different manners: locally via the operator interface, via a digital input, or via a building management system. Consult the supplied wiring diagram for the proper wiring configuration should a digital input or the building management method of control are desired to be utilized. By default, the EVAPCO Controller will be set to local control via the operator interface. Note that it is possible to use a building management system to only monitor the EVAPCO Controller while the on/off control is done locally at the operator interface.

Parameter	Description	Default
Digital Input	Allows the eco-Air unit to be activated via a digital input.	No
Supervisor	Allows the eco-Air unit to be activated via a BAS.	No

**Table 19 - Unit Activation Parameters**

A secondary setpoint may be used to control the process temperature and may be activated via the scheduler, an ambient temperature, or a digital input. If the secondary setpoint is to be activated via a digital input, consult the supplied wiring diagram to determine the proper wiring configuration. If the secondary setpoint is to be set via an ambient temperature, additional parameters will be accessible. If the secondary setpoint is to be activated via the scheduler, reference the Scheduler section of this document for an explanation of how to configure the time and day of the week that the secondary setpoint is active.

Parameter	Description	Default
Setpoint 2 Trigger Source	Sets the secondary setpoint trigger as disable, ambient temperature, scheduler, or digital input.	Disable
Ambient Setpoint	The temperature above which the secondary setpoint is triggered.	-15 °C
Ambient Differential	Used in combination with the ambient setpoint to determine a band at which the secondary setpoint is active.	-17.22 °C

**Table 20 - Secondary Setpoint Trigger Parameters**

The Quiet Mode limits the maximum allowable fan speed and may be activated via the scheduler or a digital input. To set the maximum fan speed allowed in Quiet Mode, please see Figure 31. If Quiet Mode is to be activated via a digital input, consult the supplied wiring diagram to determine the proper wiring configuration. **Note that limiting the maximum fan speed will impact the thermal performance of the eco-Air unit.**

Parameter	Description	Default
Quiet Mode Trigger	Sets the quiet mode trigger as disable, scheduler, or digital input.	Disable

**Table 21 - Quiet Mode Trigger Parameters**

The following feature is only applicable for eco-Air units that are equipped with EC Fan motors with the fail-safe functionality built into the fan. The parameters associated with the fail-safe functionality are shown in Figure 36. In the event that the EC fan motors lose communication with the EVAPCO Controller, the EC fan motors have the ability to run at a predetermined speed. This is initiated if communication is lost for a set amount of time. For example, if the fail-safe function is enabled, the EC fan motors will run at 100% after 5 seconds of no response from the controller. Note that due to the nature of Modbus communication, the delay time should not be set below 5 seconds since there is an inherent latency.

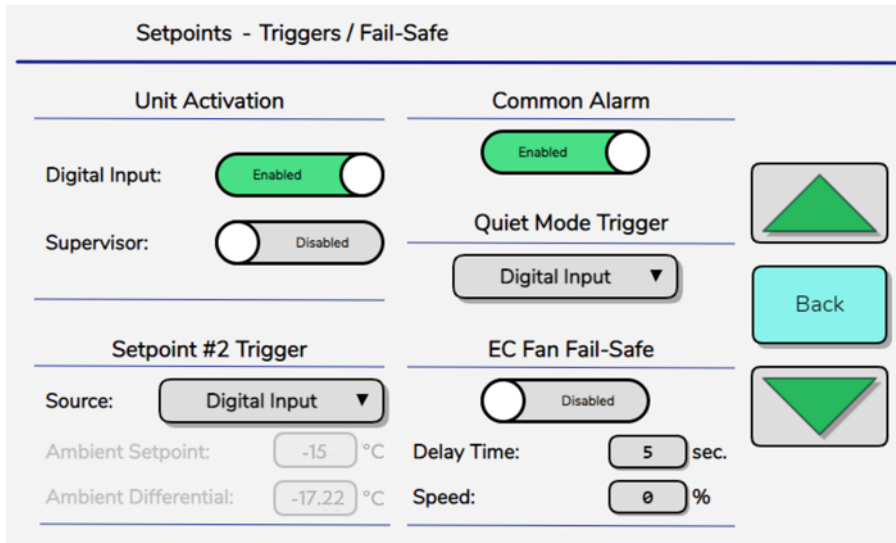

Figure 36 - Various Modes of Operation Triggers with EC Fan Fail-Safe Function Visible

Parameter	Description	Default
Enable Failsafe	Enables or disables the failsafe feature.	No
Delay Time	The amount of time that must elapse before the failsafe feature is activated.	30 seconds
Speed	The fan motor speed at which the fans will run if the failsafe feature is initiated.	100%

Table 22 - Fail-Safe Mode Parameters

Remote control of the fan speed may be enabled by pressing the toggle switch in Figure 37. By enabling remote control, the locally calculated fan speed is circumvented by either an analog input signal or via communications. While operating in remote speed control, the minimum and maximum fan speed setpoints on the local controller will still be enforced. The fans will begin to operate when the unit is enabled and either the signal reaches 5% of the input range ~ 4.8mA, for analog input or greater than 0.1% via communication.

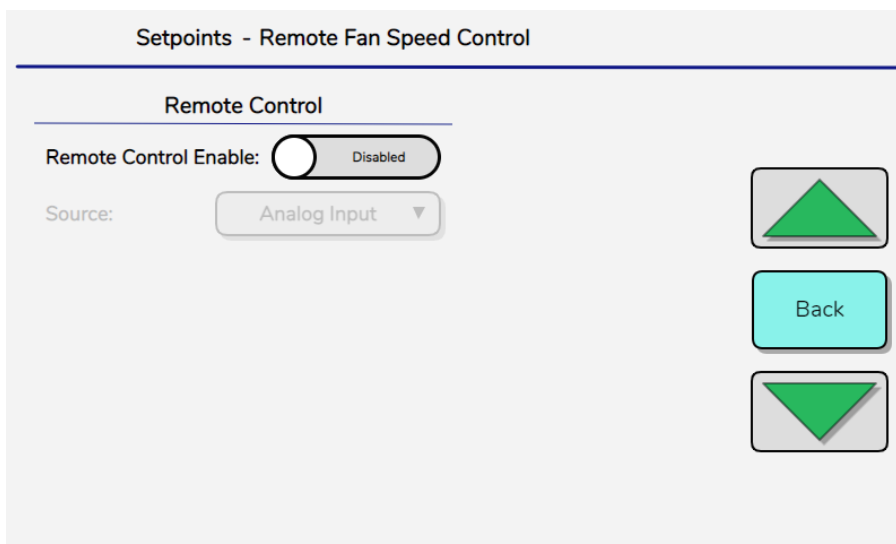

Figure 37 - Remote Fan Speed Control Parameters

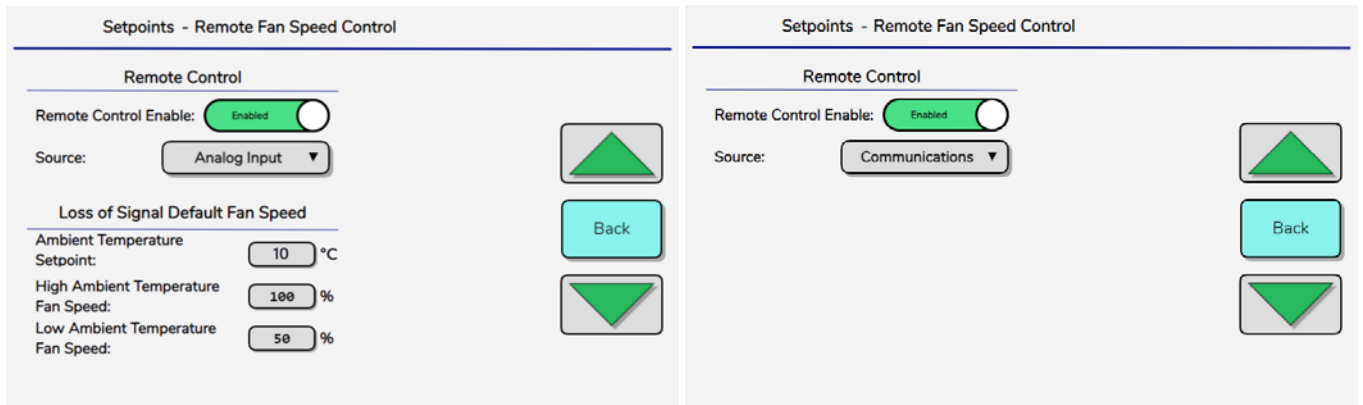

Figure 38 - Analog Input or Communication Sources for Remote Fan Speed Control

Parameter	Description	Default
Remote Control Enable	Enables or disables the remote fan speed control.	Disabled
Source	Select whether the fan speed is referenced based an analog input or via communications.	Analog Input
Ambient Temperature Setpoint	When operating based on the analog input, the ambient temperature setpoint will determine whether the fans operate at the high fan speed or low fan speed with loss of signal.	10 °C
High Ambient Temperature Fan Speed	With the loss of the analog signal, if the ambient temperature is greater than the setpoint, the fans will operate at this speed.	100 %
Low Ambient Temperature Fan Speed	With the loss of the analog signal, if the ambient temperature is less than the setpoint, the fans will operate at this speed.	50%

Table 23 - Fail-Safe Mode Parameters

The settings screen allows for the adjustment of the working hours and sensor probe values. The value of the process temperature or pressure transducer and ambient temperatures sensors may be adjusted with a linear offset. The working hours can be adjusted or set to zero to reset the value possibly after maintenance/inspection or replacement has been performed. The system measurement parameters will allow the units of measurement to be switched between SI and IP. Note, transitioning between the different units of measurement will not automatically convert temperature and pressure parameters in the other menus.

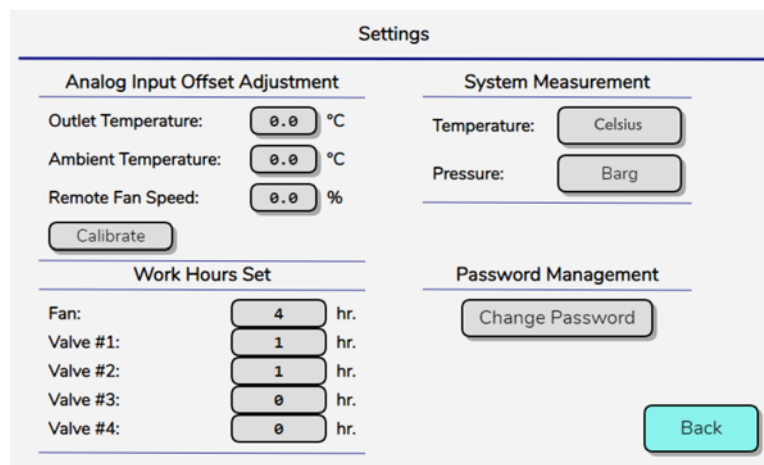

Figure 39 - Settings Screen

While the unit is off, the calibrate button is selectable. For each analog input, the Raw Value is the 4-20mA reading on the channel. For either an open signal or short, the raw value will be -48.43 mA. To calibrate the input, apply a known 4 mA signal and change the Low Value to match the raw value reading. Next apply a 20 mA signal and change the High Value to match the raw value reading.

**Settings - Analog Inputs**

Analog Input	Raw Value	Low Value	High Value
Process Sensor	10.52 mA	4.00 mA	20.00 mA
Ambient Temperature Sensor	10.38 mA	4.00 mA	20.00 mA
Remote Fan Speed	-48.43 mA	3.93 mA	19.64 mA
Analog In #4	-48.43 mA	4.00 mA	20.00 mA
Analog In #5	-48.43 mA	4.00 mA	20.00 mA
Analog In #6	-48.43 mA	4.00 mA	20.00 mA
Analog In #7	-48.43 mA	4.00 mA	20.00 mA
Analog In #8	-48.43 mA	4.00 mA	20.00 mA
Analog In #9	-48.43 mA	4.00 mA	20.00 mA

**Figure 40** - Analog Input Calibration Screen

To change the Service level password, press the Change Password button. In the popup window, enter the current password, the new password and confirmation of the new password. If the new password does not match the confirm password, the confirm password field turns red and the Ok button cannot be pressed.

**Settings**

**Analog Input Offset Adjustment**

Outlet Temperature:  °C

Ambient Temperature:  °C

Remote Fan Speed:  mA

**Work Hours**

Fan:  hr.

Valve #1:  hr.

Valve #2:  hr.

Valve #3:  hr.

Valve #4:  hr.

**System Measurement**

Fahrenheit

Barg

Management

Password

**User Name:**

**Password:**

**New Password:**

**Confirm Password:**

**Figure 41** - Changing the Service Level Password

Manual Management allows several operations of the EVAPCO Controller to be manually triggered or controlled. Note that while being controlled manually, the EVAPCO Controller will not have the ability to maintain a specific process setpoint. The Analog Output of Fans Screen allows the fan speed to be manually adjusted to any speed between 0% and 100% once the Manual Management function is enabled.

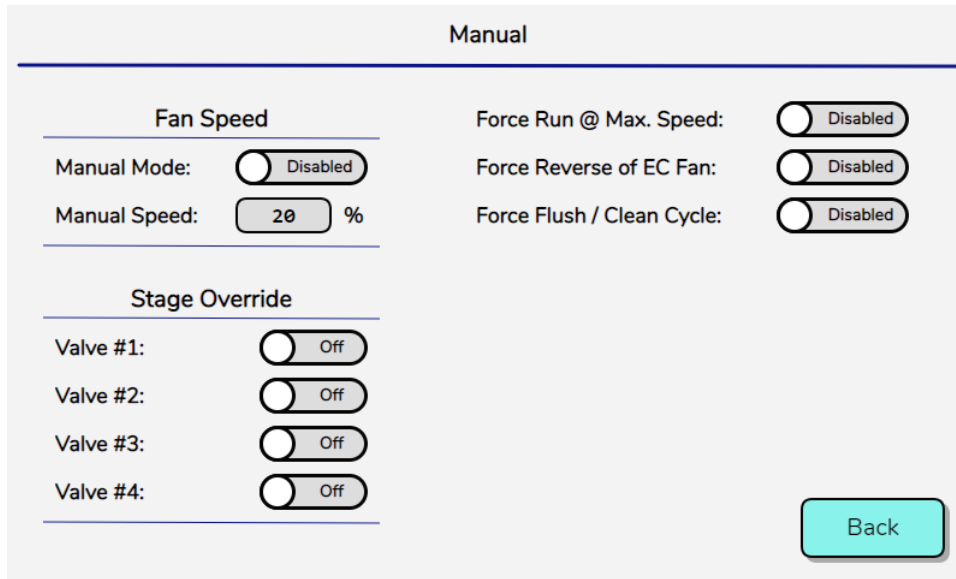

Figure 42 - Manual Operation of Unit

Parameter	Description	Default
Manual Management	Enables or disables the manual fan speed.	Disable
Manual Speed	The manual fan speed setpoint.	0%

Table 24 - Manual Fan Speed Parameters

The Stage Override allows any stage of the precooling system to be enabled or disabled manually. Note that manually overriding the precooling system stages ignores all automatic logic such as minimum ambient temperature and minimum on time once activated.

Parameter	Description	Default
Stage #1 - 4	Manually opens or closes the precooling system valve.	Off

Table 25 - Manual Pre-Cooling System Operation Parameters

Additionally, three other features are available in the manual screen:

- Force the fan motors to run at the maximum allowable speed.
- Force EC fan motors to rotate in the reverse direction.
- Force a precooling system flush cycle based on the timers set in Figure 20



The working hours screen displays the current working hours of the fan motors, and the precooling system valves since the last reset of the working hours. To reset the working hours, see Figure 38.

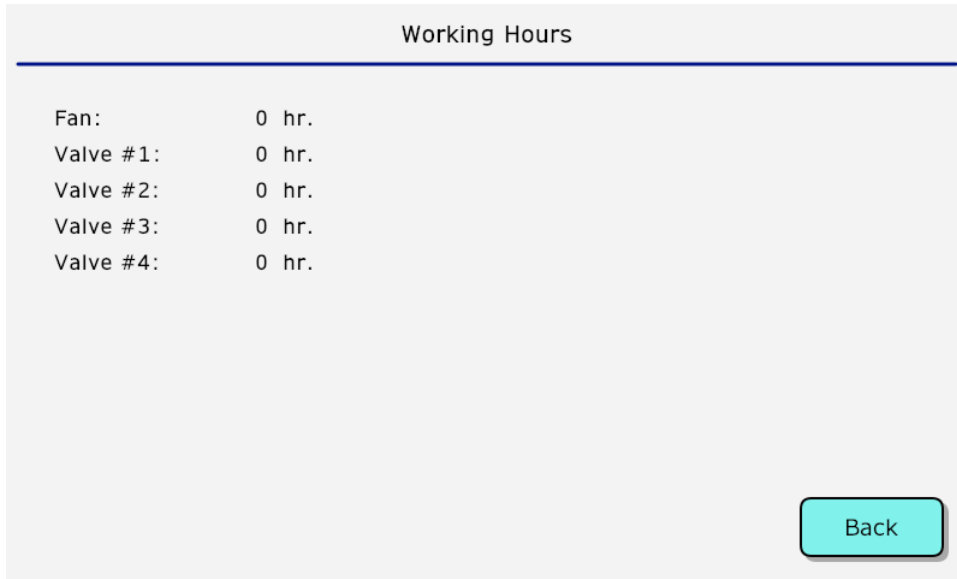

**Figure 43** - Fan and Solenoid Valves Working Hours.

To perform an I/O test, the eco-Air unit must be switched off (Figure 18). The test must first be enabled. After being enabled, the digital outputs may be manually turned On and Off. This feature should only be used during commissioning or to ensure proper wiring of the device. Note that enabling the I/O test will circumvent normal operation of the hardware. Turning an output on will cause the device attached to the output to function.

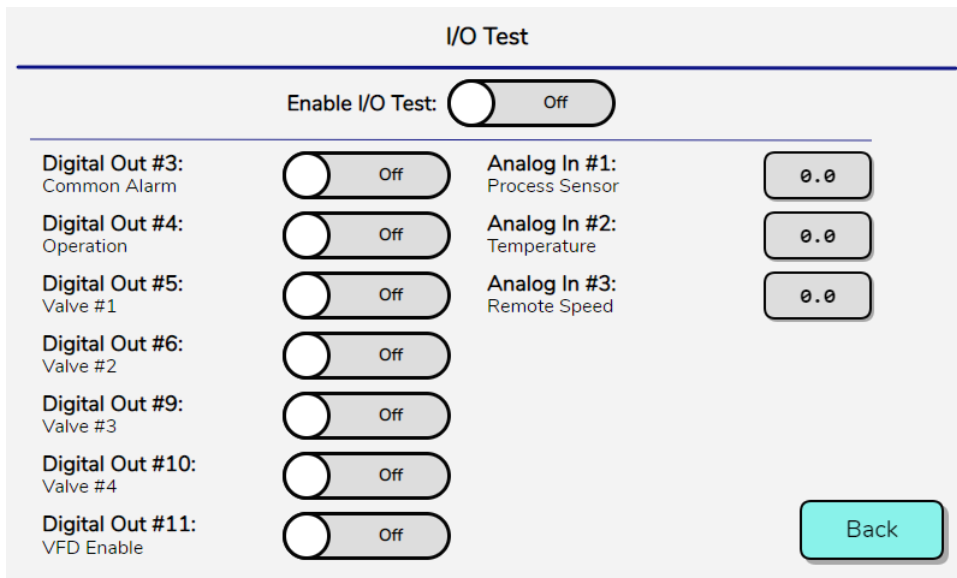

**Figure 44** - Digital and Analog Inputs I/O Testing

All EVAPCO Controllers can communicate with a BMS via Modbus RTU, Modbus TCP/IP, BACnet MS/TP, and BACnet IP. Consult the supplied wiring diagram for the proper wiring configuration. The BMS configuration screen allows the various communication parameters to be set. After changing any of the communication parameters, the Update button must be pressed for 3 seconds for the change to take effect. Note, pressing the Update button will restart the PLC.

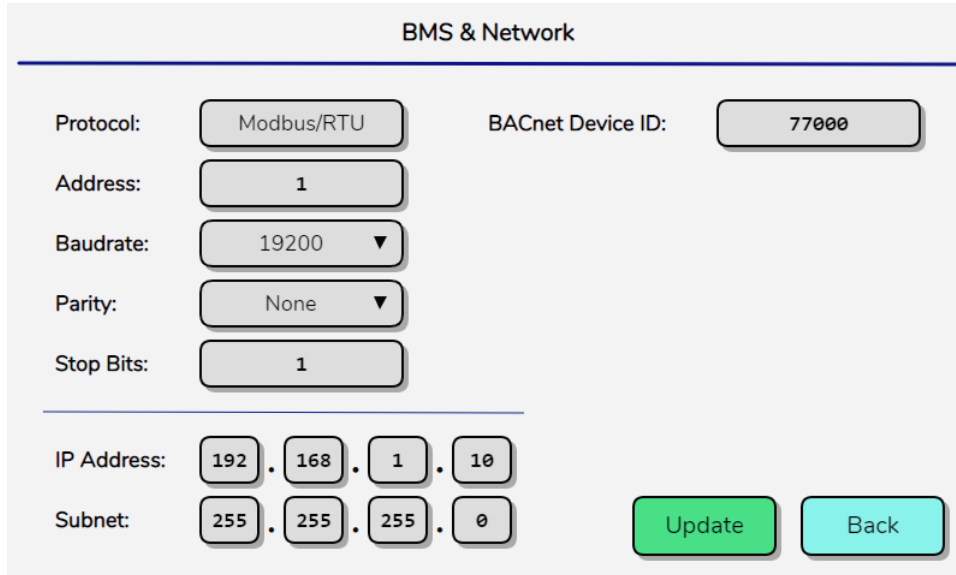

**Figure 45** - BMS Configuration Screen for Serial and Ethernet Communications

Parameter	Description	Default
Protocol	Select which protocol will be communicated on the serial network: Modbus RTU or BACnet MS/TP	Modbus RTU
Address	The node address of the EVAPCO Controller: 1 to 254.	1
Baudrate	The baud rate of the Modbus RTU or BACnet MS/TP signal: 19200, 38400, 57600, 76800, 115200.	19200
Parity	The parity of the Modbus RTU signal: None, Even, Odd	Even
Stop Bits	The number of stop bits: 1 or 2.	1
BACnet Device ID	The unique device ID number for the unit: 1 to 4,194,303	77000

**Table 26** - BMS Configuration Parameters

## Manufacturer Screens

The **Manufacturer Screens** are for use by EVAPCO authorized factory technicians to configure the EVAPCO Controller.

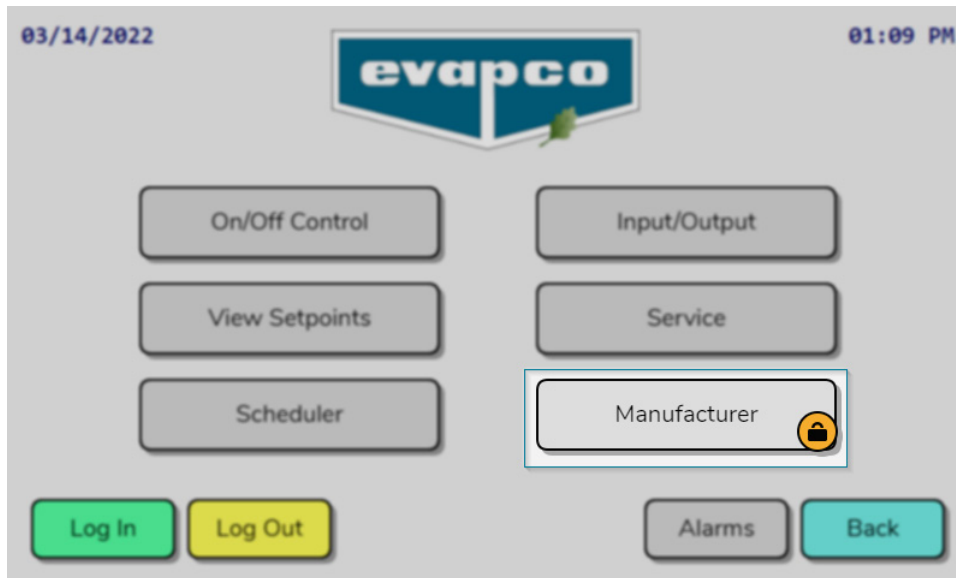

**Figure 46** - Manufacturer Button on Main Menu

### Terminology

**BMS (Building Management System):** Also referred to BAS (Building Automation System) is a system that allows users to control multiple equipment from a central location.

**PID (Proportional-Integral-Derivative) Controller:** A control loop feedback mechanism used in industrial control systems. By adjusting control outputs, a PID controller attempts to minimize the difference between a measure process variable and a desired setpoint.

**PLD (Programmable Logic Controller):** A programmable microprocessor that performs switching, timing and process control tasks.

**HMI (Human Machine Interface):** A visual touch screen that facilitates users' interaction with the PLC and allows for the monitoring of data points and setting of parameters.

**VFD (Variable Frequency Drive):** A controller that drives an electric motor by varying the input frequency and voltage to the electric motor.

## Alarm Event Description

Alarm	Description
Analog Input #1 Error	The sensor probe connected to analog input #1 is not providing the expected feedback.
Analog Input #2 Error	The sensor probe connected to analog input #2 is not providing the expected feedback.
Fan Fault #1	The motor drives connected to the fan fault #1 digital input have tripped.
Fan Fault #2	The motor drives connected to the fan fault #2 digital input have tripped.
Fan Fault #3	The motor drives connected to the fan fault #3 digital input have tripped.
Fan Fault #4	The motor drives connected to the fan fault #4 digital input have tripped.
Fan Fault #5	The motor drives connected to the fan fault #5 digital input have tripped.
Fan Fault #6	The motor drives connected to the fan fault #6 digital input have tripped.
VFD Fault	The VFD connected to the fan motors has tripped. Reference the drive's HMI for information on the specific error that has stopped operation.
Valve Fault	The power for the precooling system valves is not active.
Vibration Switch Triggered	At least one of the vibration switches on the unit has tripped.
Fan #1 Offline	The controller is unable to communicate with EC fan motor 1.
Fan #2 Offline	The controller is unable to communicate with EC fan motor 2.
Fan #3 Offline	The controller is unable to communicate with EC fan motor 3.
Fan #4 Offline	The controller is unable to communicate with EC fan motor 4.
Fan #5 Offline	The controller is unable to communicate with EC fan motor 5.
Fan #6 Offline	The controller is unable to communicate with EC fan motor 6.
Fan #7 Offline	The controller is unable to communicate with EC fan motor 7.
Fan #8 Offline	The controller is unable to communicate with EC fan motor 8.
Fan #9 Offline	The controller is unable to communicate with EC fan motor 9.
Fan #10 Offline	The controller is unable to communicate with EC fan motor 10.
Fan #11 Offline	The controller is unable to communicate with EC fan motor 11.
Fan #12 Offline	The controller is unable to communicate with EC fan motor 12.
Fan #13 Offline	The controller is unable to communicate with EC fan motor 13.
Fan #14 Offline	The controller is unable to communicate with EC fan motor 14.
Fan #15 Offline	The controller is unable to communicate with EC fan motor 15.
Fan #16 Offline	The controller is unable to communicate with EC fan motor 16.
Fan #17 Offline	The controller is unable to communicate with EC fan motor 17.
Fan #18 Offline	The controller is unable to communicate with EC fan motor 18.
Fan #19 Offline	The controller is unable to communicate with EC fan motor 19.
Fan #20 Offline	The controller is unable to communicate with EC fan motor 20.



For Single Stack units equipped with EC type fans, the following is a list of alarms and warnings pertaining to the motors. The list is typical of Fan #1 to Fan #20.

Alarm	Description
Fan #1 Phase Failure Alarm	A phase of the supply voltage is either lost or poor grid quality
Fan #1 Output Stage Overheating Alarm	The temperature of the motor drive has exceeded a safety limit. Ensure the motor electronics housing is clean of debris.
Fan #1 Internal Communication Error Alarm	The controllers within the fan have lost communication.
Fan #1 Motor Overheating Alarm	The ambient temperature around the motor is too high.
Fan #1 Hall Sensor Error Alarm	An internal error has occurred with the hall sensor. Power cycle the motor to attempt to clear the alarm.
Fan #1 Motor Blocked Alarm	The motor has been blocked and does not have freedom of movement.
Fan #1 Speed Limit Exceeded Alarm	The motor has exceeded the speed limit.
Fan #1 Rotor Position Sensor Calibration Error Alarm	The motor positioning sensor has lost calibration. The fan manufacturer must recalibrate the fan.
Fan #1 DC-Link Undervoltage Alarm	The line voltage of the motor is faulty.
Fan #1 Current Limitation Engaged Warning	The fan controller is limiting the current based on internal calculations of the maximum permissible current.
Fan #1 Line Impedance High Warning	The line impedance is too high causing an unstable DC-link voltage.
Fan #1 Power Limitation Engaged Warning	The fan controller is limiting the fan power based on internal calculations of the maximum permissible power.
Fan #1 Output Stage Temperature High Warning	The output staging temperature is reaching the alarm trip point.
Fan #1 Motor Temperature High Warning	The motor temperature is reaching the alarm trip point
Fan #1 Electronics Temperature High Warning	The temperature monitoring within the motor controller electronics has exceeded the warning temperature limit.
Fan #1 DC-Link Voltage Low Warning	The DC-link voltage is reaching the alarm trip point.
Fan #1 Brake Operation Warning	The motor has experienced an external force that has caused the fan to run in the wrong direction at high speed for a prolonged period of time.
Fan #1 DC-Link Voltage High Warning	The internal DC-link voltage is high.
Fan #1 Line Voltage High Warning	The line voltage to the motor is high.
Fan #1 Shedding Active Warning	The fan is attempting to shed obstructions that may have accumulated on the fan blades.

For Double Stack units equipped with EC type fans, the following is a list of alarms and warnings pertaining to the motors. The list is typical of Fan #1 to Fan #12.

Alarm	Description
Fan #1 Low Line Voltage Alarm	The line voltage is too low.
Fan #1 High Line Voltage Alarm	The line voltage is too high
Fan #1 High Current Motor Short Alarm	The motor current is too high indicating a short in the motor cable or the motor windings.
Fan #1 High Temperature Warning	The internal temperature of the motor drive is too high.
Fan #1 Input Phase Error Warning	A phase is missing for the supply voltage or there is a large imbalance in the supply voltage.
Fan #1 Rotor Blocked Alarm	The rotor is unable to rotate due to a mechanical blockage of the rotor or fan.
Fan #1 Current Limit Warning	The motor power has reached the maximum permissible power and the drive is limiting the current.
Fan #1 Voltage Limit Warning	The motor power has reached the maximum permissible power and the drive is limiting the voltage.
Fan #1 Rotor Direction Alarm	The rotor of the motor is spinning in the opposite direction
Fan #1 EEPROM Error Warning	An internal error has occurred with the motor controller.
Fan #1 Internal Stop Alarm	The motor has been stopped by the mounted controller.
Fan #1 Earth Fault Alarm	An earth fault has been detected on the motor cables or motor windings.
Fan #1 Motor Phase Error Alarm	One of motor of the motor phases/windings are disconnected
Fan #1 Internal Communication Error Alarm	An internal error has occurred with the motor controller.
Fan #1 Voltage Ripple Warning	Imbalance has been detected on the voltage supply.
Fan #1 Motor Controller In Bootloader Alarm	The drive is currently in bootloader.
Fan #1 Windmilling Warning	The motor is windmilling in the opposite direction during the startup process



# WORLDWIDE MANUFACTURING FACILITIES



- World Headquarters/ Research and Development Center
- EVAPCO Manufacturing Facilities

## EVAPCO, Inc. — World Headquarters & Research / Development Center

P.O. Box 1300 • Westminister, MD 21158 USA  
410.756.2600 • [marketing@evapco.com](mailto:marketing@evapco.com) • [evapco.eu](http://evapco.eu)

### North America

- EVAPCO, Inc. World Headquarters**  
Westminister, MD USA  
410.756.2600  
[marketing@evapco.com](mailto:marketing@evapco.com)
- EVAPCO East**  
Taneytown, MD USA
- EVAPCO East**  
Key Building  
Taneytown, MD USA
- EVAPCO Midwest**  
Greenup, IL USA  
217.923.3431  
[evapcomw@evapcomw.com](mailto:evapcomw@evapcomw.com)
- Evapcold Manufacturing**  
Greenup, IL USA
- EVAPCO Newton**  
Newton, IL USA  
618.783.3433  
[evapcomw@evapcomw.com](mailto:evapcomw@evapcomw.com)
- EVAPCO West**  
Madera, CA USA  
559.673.2207  
[contact@evapcowest.com](mailto:contact@evapcowest.com)
- EVAPCO Alcoil, Inc.**  
York, PA USA  
717.347.7500  
[info@evapco-alcoil.com](mailto:info@evapco-alcoil.com)
- EVAPCO Iowa**  
Lake View, IA USA
- EVAPCO Iowa**  
Sales & Engineering  
Medford, MN USA  
507.446.8005  
[evapcomn@evapcomn.com](mailto:evapcomn@evapcomn.com)
- EVAPCO LMP ULC**  
Laval, Quebec, Canada  
450.629.9864  
[info@evapcolmp.ca](mailto:info@evapcolmp.ca)
- EVAPCO Select Technologies, Inc.**  
Belmont, MI USA  
844.785.9506  
[emarketing@evapcoselect.com](mailto:emarketing@evapcoselect.com)
- Refrigeration Vessels & Systems Corporation**  
Bryan, TX USA  
979.778.0095  
[rvs@rvscorp.com](mailto:rvs@rvscorp.com)
- Tower Components, Inc.**  
Ramseur, NC USA  
336.824.2102  
[mail@towercomponentsinc.com](mailto:mail@towercomponentsinc.com)
- EvapTech, Inc.**  
Edwardsville, KS USA  
913.322.5165  
[marketing@evaptech.com](mailto:marketing@evaptech.com)
- EVAPCO Dry Cooling, Inc.**  
Bridgewater, NJ USA  
908.379.2665  
[info@evapcodc.com](mailto:info@evapcodc.com)
- EVAPCO Dry Cooling, Inc.**  
Littleton, CO USA  
908.895.3236  
[info@evapcodc.com](mailto:info@evapcodc.com)
- EVAPCO Power México S. de R.L. de C.V.**  
Mexico City, Mexico  
(52) 55.8421.9260  
[info@evapcodc.com](mailto:info@evapcodc.com)

### Asia Pacific

- EVAPCO Asia Pacific Headquarters**  
Baoshan Industrial Zone Shanghai, P.R. China  
(86) 21.6687.7786  
[marketing@evapcochina.com](mailto:marketing@evapcochina.com)
- EVAPCO (Shanghai) Refrigeration Equipment Co., Ltd.**  
Baoshan Industrial Zone, Shanghai, P.R. China
- EVAPCO (Beijing) Refrigeration Equipment Co., Ltd.**  
Huairou District, Beijing, P.R. China  
(86) 10.6166.7238  
[marketing@evapcochina.com](mailto:marketing@evapcochina.com)
- EVAPCO Air Cooling Systems (Jiaxing) Company, Ltd.**  
Jiaxing, Zhejiang, P.R. China  
(86) 573.8311.9379  
[info@evapcochina.com](mailto:info@evapcochina.com)
- EVAPCO Australia (Pty.) Ltd.**  
Riverstone, NSW, Australia  
(61) 02.9627.3322  
[sales@evapco.com.au](mailto:sales@evapco.com.au)
- EvapTech (Shanghai) Cooling Tower Co., Ltd**  
Baoshan District, Shanghai, P.R. China.  
Tel: (86) 21.6478.0265
- EvapTech Asia Pacific Sdn. Bhd.** Puchong, Selangor, Malaysia  
(60) 3.8070.7255  
[marketing-ap@evaptech.com](mailto:marketing-ap@evaptech.com)

### Europe | Middle East | Africa

- EVAPCO Europe EMENA Headquarters**  
Tongeren-Borgloon, Belgium  
(32) 12.39.50.29  
[info@evapco.be](mailto:info@evapco.be)
- EVAPCO Europe BV**  
Tongeren-Borgloon, Belgium
- EVAPCO Europe, S.r.l.**  
Milan, Italy  
(39) 02.939.9041  
[evapcoeuropa@evapco.it](mailto:evapcoeuropa@evapco.it)
- EVAPCO Europe, S.r.l.**  
Sondrio, Italy
- EVAPCO Europe A/S**  
Aabybro, Denmark  
(45) 9824.4999  
[info@evapco.dk](mailto:info@evapco.dk)
- EVAPCO Europe GmbH**  
Meerbusch, Germany  
(49) 2159.69560  
[info@evapco.de](mailto:info@evapco.de)
- EVAPCO Middle East DMCC**  
Dubai, United Arab Emirates  
(971) 56.991.6584  
[info@evapco.ae](mailto:info@evapco.ae)
- Evap Egypt Engineering Industries Co.**  
*A licensed manufacturer of EVAPCO, Inc.*  
Nasr City, Cairo, Egypt  
(20) 10.054.32.198  
[evapco@tiba-group.com](mailto:evapco@tiba-group.com)
- EVAPCO S.A. (Pty.) Ltd.**  
*A licensed manufacturer of EVAPCO, Inc.*  
Isando, South Africa  
(27) 11.392.6630  
[evapco@evapco.co.za](mailto:evapco@evapco.co.za)

### South America

- EVAPCO Brasil**  
Equipamentos Industriais Ltda.  
Indaiatuba, São Paulo, Brazil  
(55) 11.5681.2000  
[vendas@evapco.com.br](mailto:vendas@evapco.com.br)
- FanTR Technology Resources**  
Itu, São Paulo, Brazil  
(55) 11.4025.1670  
[fantr@fantr.com](mailto:fantr@fantr.com)