

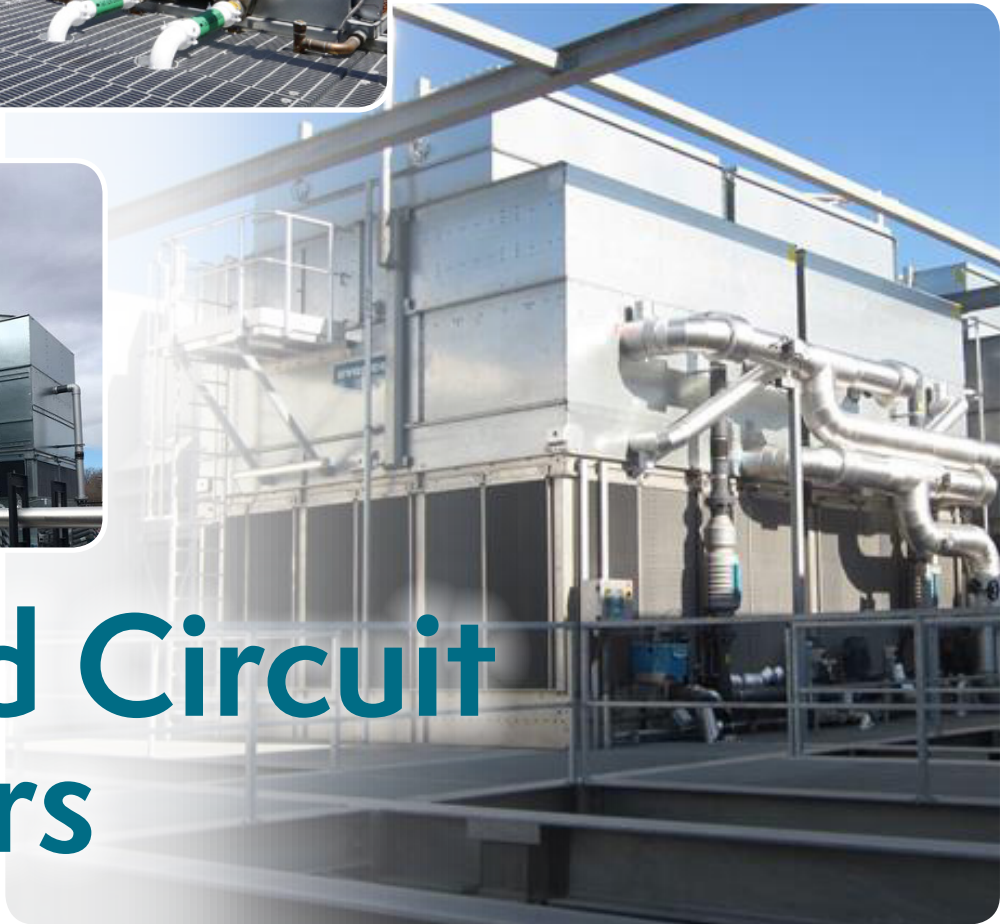

for LIFE

CLOSED CIRCUIT COOLERS



Closed Circuit Coolers

ENHANCED COOLING EFFICIENCY
Reduced Water Consumption. Performance Guaranteed.

About EVAPCO



EVAPCO for LIFE

EVAPCO is more than a name. We are the global innovator in heat transfer solutions for the commercial HVAC, industrial refrigeration, power and industrial process markets. We pledge to make everyday life easier, more comfortable, more reliable and more sustainable for people everywhere.

OUR COMMITMENT

We never stop innovating. We set out to find groundbreaking solutions that transform the way the world works for the better. It's why we have more than 50 active U.S. patents and nearly 200 foreign counterparts. We also guarantee performance and put every solution through rigorous research and testing to ensure maximum efficiency and reliability.



PROTECTING THE ENVIRONMENT

Innovation and environmental sustainability go hand-in-hand at EVAPCO. Our industrial heat transfer equipment not only conserves natural resources and helps reduce noise pollution, but also features recycled steel content in construction. Our stainless steel units are constructed of panels that contain up to 67% of recycled content and our galvanized units contain more than 79%. From sound reduction to water conservation to chemical elimination, we are developing new technologies that deliver ultimate operating advantages to our clients while protecting the planet for every generation to come.





THROUGH THE YEARS

Since the beginning,
we have never stopped
INNOVATING.

EVAPCO's closed circuit cooler solutions are highly engineered with quality components and manufactured to exacting standards. The durable materials of construction ensure the longevity expected of EVAPCO products. EVAPCO offers an extensive selection of closed circuit coolers for new construction and replacement projects. Our closed circuit cooler products are:



CTI certified, IBC compliant and ASHRAE 90.1 compliant

With customer satisfaction as our number one priority, we strive to provide you with the best solution for every project.



DATA
CENTERS



INDUSTRIAL
PROCESS

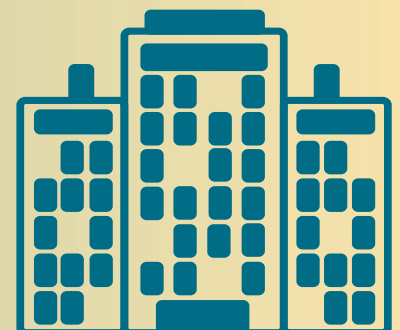

COMFORT
COOLING

† Mark owned by the Cooling Technology Institute

* Mark owned by ASHRAE

The Closed Loop Advantage

What's the Advantage?

It's a common question during the early design phase of large mechanical systems: "Is open-loop or closed-loop cooling equipment better suited for this project?" When it comes to modern heat rejection technology, both open-loop and closed-loop cooling equipment provide a distinct set of advantages for the engineer, installer and building owner. The specific cooling needs of the application, along with the physical parameters of the installation site, budgetary considerations and environmental goals should ultimately determine the type of system that's best-suited and specified.

Over the past decade, EVAPCO has pioneered innovation in the closed circuit cooler market, along with advancements and refining of tried-and-true open-loop equipment options. With very real concerns about the higher water consumption of open-loop systems, closed-loop cooling technology is gaining broader appeal every year. When properly designed for the commercial or industrial process cooling load, both system types can offer unparalleled energy efficiency, reliability and longevity. Determining which system is best-suited to a certain application is a task left for the specifying engineer and others who are intimately familiar with the needs of the property.

Why Choose Open-Loop Equipment?

- Highest efficiency due to the direct latent heat transfer of the tower water loop being 'open' to the atmosphere
- Lowest connected HP
- Smallest footprint
- Lowest first cost
- Closest approach to WB

Additional Considerations

- High water & energy usage
- Water treatment, passivation (Z-725 Steel)
- Routine maintenance - belts, fill media, basin cleaning, nozzle cleaning, etc.
- Heat exchanger maintenance – additional piping/valving, etc.
- Chiller maintenance if the condenser water supply is piped directly to the Open Tower

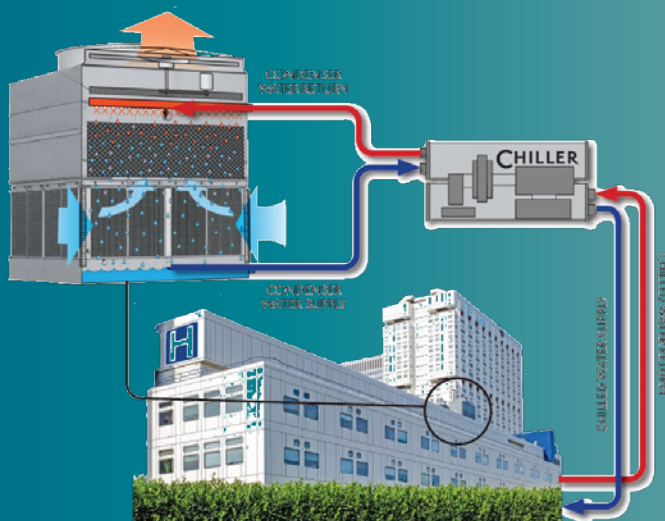

Open Loop Tower Piped to Chiller

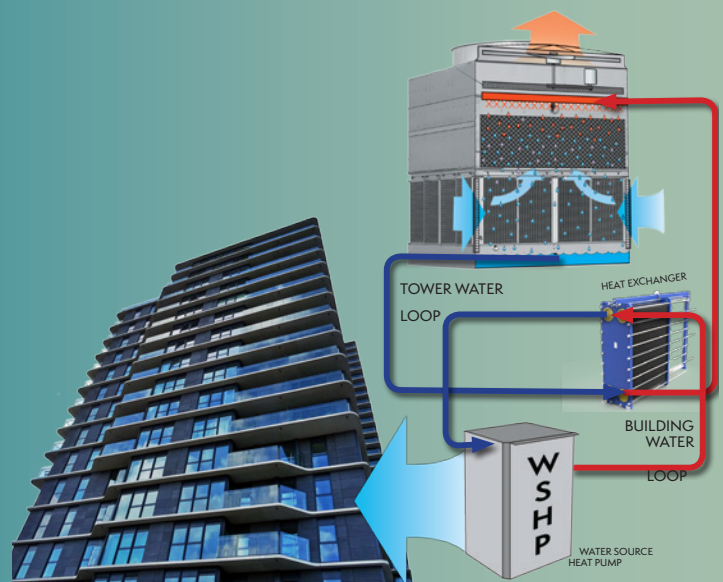

Open Loop Tower Piped to Heat Exchanger, Piped to Water Source Heat Pump

Closed-Loop Technology

EVAPCO's wide range of closed circuit coolers, or simply "fluid coolers" provide a heat rejection alternative for engineers or end users who want (or need) to reduce water consumption and equipment maintenance, or a number of other considerations that exist with open-loop cooling applications. Some cooling applications require a closed-loop system for peak-efficiency long term operation. These types of systems generally include the use of small heat exchangers in terminal units or other connected equipment, making maintenance complicated, if at all possible. For example, buildings with water-source heat pump loops – widely used for office, hotel and health care facilities – are among one of the largest markets for fluid coolers. Using an open-cooling loop could pose the significant risk of fouling hundreds of heat exchangers in a condominium or similar facility. Closed circuit systems are also prevalent among data centers, battery plants, grow room facilities, high-efficiency chiller applications and multiple different types of industrial process loops. Water loss through evaporation is either reduced or eliminated, depending on the type of closed-loop cooling equipment selected. The same is true for water treatment chemicals and/or systems; closed-loop technology can help to dramatically reduce or even eliminate the need for chemical treatment of system fluids.

Why Choose Closed-Loop Equipment?

- No heat exchanger needed – process fluid stays in a closed loop
- Ability to send alternate fluids directly to the closed circuit cooler, such as oils, glycols, bitcool, etc.
- Significantly reduces Chiller/WSHP maintenance & downtime
- Dry operation capability – water savings, more options to winterize
- Larger than towers due to "indirect" nature of heat transfer –evaporation takes place on coil surface
- Finned coils & hybrid options can greatly increase efficiency & hours of dry operation
- Reduced water treatment expenses

Heat Rejection

Compared to open-loop cooling towers, fluid coolers provide more flexibility in terms of where heat rejection equipment is installed. Closed-loop systems also do not require hydraulic balancing or equalization. Because of this, fluid coolers can be installed at or below the level of the connected system piping. Conversely, installing a cooling tower below grade or below the pump could result in the tower flooding when the unit shuts down. Closed-loop equipment also provides an advantage for cooling systems operating in sub-freezing outdoor temperatures. Some types of closed loop equipment may still require freeze protection of some sort, but all open loop cooling towers must be equipped with basin heaters, a drain-back design or a recirculation system for idle periods in freezing conditions. Closed circuit coolers can also provide completely dry sensible heat rejection when outside ambient conditions are favorable. This dry capacity is an added benefit which can greatly reduce the overall water consumption on a project. Fluid coolers can be sized for full design or partial load based on a dry bulb switchover temperature. This means that the recirculating spray pump can be deenergized when the heat load can be fully satisfied by just the fluid cooler fans. While this operational mode greatly reduces water consumption, energy is also saved since the recirculating pump is off.

The following are four primary types of closed loop heat rejection equipment:

- Evaporative closed circuit coolers
- Eco/Hybrid closed circuit coolers
- Adiabatic coolers
- Dry coolers

The cooling load of the system, available equipment space, sensitivity to water consumption, maintenance requirements, and project budget should determine which option is best for the specific application.

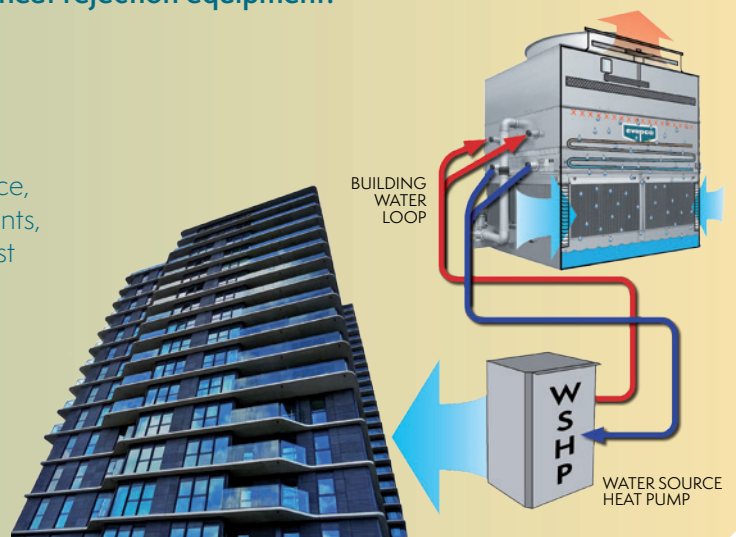

Closed Loop Cooler Piped to Water Source Heat Pump

FULL SPECTRUM OF GLOBAL SOLUTIONS



Hybrid



Evaporative

Induced Draft

Forced Draft



ATWB



LSWE



ESW4



LRWB



PHW

With ease of system maintenance and sustainability in mind, the **Evaporative** line of closed circuit coolers is the first stop on the "Full Spectrum" of EVAPCO's closed circuit cooler global solutions. Highly versatile, the coolers have a variety of applications, from cooling industrial process equipment to maintaining temperatures in data centers and computer rooms to chemical manufacturing. Learn more about the above evaporative closed circuit cooler options on page 8 to 13.

Induced Draft

Forced Draft



eco-ATWB



eco-LSWE



eco-ATWB-H



eco-LRWB

Moving to the right on our "Full Spectrum" of closed circuit coolers, we offer our **Hybrid** solutions. By utilizing our externally enhanced ellipti-fin® coil technology, we gain a 30% (and more) bump in both evaporative and dry performance. This will result in higher dry bulb switchover temperatures, smaller unit footprints, and reduced water and energy consumption. Learn more about the above hybrid closed circuit cooler options on page 14 to 19.

As the leader in evaporative and dry technology, EVAPCO offers a number of closed circuit cooler solutions, strategically designed for ease of maintenance while efficiently optimized for water and energy reduction. Allow us to utilize our state-of-the-art equipment to meet the needs of your application, all while maintaining the latest industry standards.



Adiabatic



Air Cooled



EAW-VA



EAW-VS



EAW-DA



EAW-FD



EAW-VD



EAW-DD



† Mark owned by the Cooling Technology Institute

Finishing up the “Full Spectrum” of EVAPCO’s closed circuit cooler global solutions is the eco-Air Series of **Adiabatic** and **Air Cooled** units. Available in fully dry, adiabatic and spray designs, the eco-Air Series maximizes heat rejection with minimal or no water use. Learn about the above adiabatic and air cooled closed circuit cooler options on page 20 to 23.

* For specific units that have FM Approval as an option, visit the FM Approval website, or find the FM Approval symbol on the specific unit’s construction features page.

** For specific units that are CTI Certified, visit the CTI website, or find the CTI symbol on the specific unit’s construction features page.

ATWB Design & Construction Features

The ATWB line of Closed Circuit Coolers has always reflected EVAPCO's commitment to product development. Its advanced design and owner oriented features provide many operational and performance advantages. The ATWB's Thermal-Pak® Coil now features CrossCool™ Internal Tube Enhancement which increases the internal heat transfer coefficient of the coil and thus increases the cooling capacity of the unit. The improved ATWB offers the most models and box sizes in the industry and is designed with IBC Compliant Construction and Eurovent-CTI Certified Performance.

Galvanized Steel Coil

Elliptical Thermal-Pak® COIL Construction Featuring CROSSCOOL™ Internal Tube Enhancement Technology

- Internal tube enhancement increases fluid turbulence providing **additional evaporative capacity**
- Elliptical return bends allows for more circuits per coil bundle increasing maximum capacity per footprint
- Coil located in the airstream increasing dry bulb switchover



Optional Factory Mounted Non-Chemical or Chemical Water Treatment Systems

The ATWB is available with either a **Pulse~Pure**® non-chemical or a **Smart Shield**® solid chemical water treatment system. The **Pulse~Pure**® and **Smart Shield**® are environmentally sensitive alternatives for treating water in evaporative cooled equipment. The **Pulse~Pure**® and **Smart Shield**® systems include all components required for an effective water treatment system; factory mounted and wired.



Most Accessible Basin

- Access from all four sides
- Large open area simplifies maintenance
- Basin may be inspected with pumps running

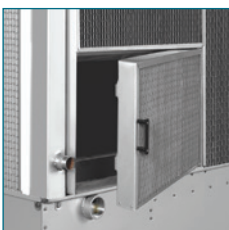

Louver Access Door

- Louver access door is available on models with 1.5 and 1.8 m tall louver sizes
- Hinged access panel with quick release mechanism
- Allows easy access to perform routine maintenance and inspection of the makeup assembly, strainer screen and basin



Super Low Sound Fan

- Extremely wide sloped fan blades for sound sensitive applications
- Molded heavy-duty construction
- 9-15 dB(A) sound reduction

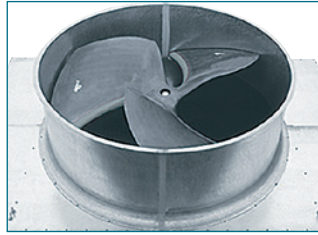

Factory Mutual Approved



Fan Drive System

- Power-band belts for better lateral rigidity
- Advanced design aluminum fan blades
- Non-corroding cast aluminum sheaves
- Heavy-duty fan shaft bearings with a minimum 100,000 hrs. L-10 life
- All other components constructed of corrosion-resistant materials
- Totally enclosed fan motors assure long life

Efficient Drift Eliminators

- Advanced design minimizing drift from the leaving air stream
- Made from corrosion resistant PVC for long life



PVC Spray Distribution Header with ZM®II Nozzles

- Large orifice fixed position nozzles prevent clogging

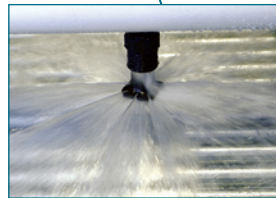

Eurovent-CTI Certified Units



† Mark owned by the Cooling Technology Institute

WST II Air Inlet Louvers (Water and Sight Tight)

- Easily removable for access
- Improved design to keep sunlight out—preventing biological growth
- Keeps water in while keeping dirt and debris out



ESW4 Design & Construction Features

The ESW family stands apart as being the most energy efficient and the quietest axial fan closed circuit coolers on the market today. The ESW4 is able to provide superior performance as a result of its optimized Sensi-Coil® Technology*. The Sensi-Coil® features CrossCool™ Internal Tube Enhancement that increases the internal heat transfer coefficient of the coil and thus increases the cooling capacity of the unit. The ESW4's owner-oriented features and independent certification of the International Building Code (IBC) compliance reinforce the ESW4's position as a premier cooler in the HVAC industry.

Eurovent-CTI Certified Units



† Mark owned by the Cooling Technology Institute

Factory Mutual Approved



Easy to Maintain Drive System

- Adjustable motor base enables the motor to swing outside the unit for easy access
- Belt tension can be easily checked and adjusted from outside the access door
- Lubrication lines are extended to the access door for added convenience



Framed WST Air Inlet Louvers (Water and Sight Tight)

- Hardware-free louver design
- One-step removal for easy access
- Improved design to keep sunlight out – preventing biological growth
- Keeps water in while keeping dirt and debris out



Optional Factory Mounted Non-Chemical or Chemical Water Treatment Systems

The ESW4 is available with either a **Pulse-Pure**® non-chemical or a **Smart Shield**® solid chemical water treatment system. The **Pulse-Pure**® and **Smart Shield**® are environmentally sensitive alternatives for treating water in evaporative cooled equipment. The **Pulse-Pure**® and **Smart Shield**® systems include all components required for an effective water treatment system; factory mounted and wired.

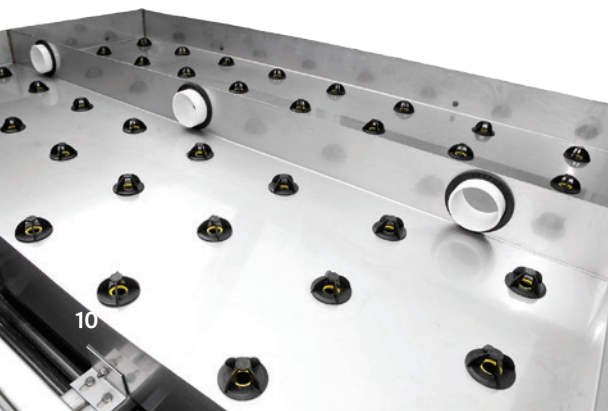

Redistribution Basin Section

- The redistribution basin ensures even water loading of the optimized **Sensi-Coil**®
- Large orifice nozzles prevent clogging
- Easily accessible for routine inspection

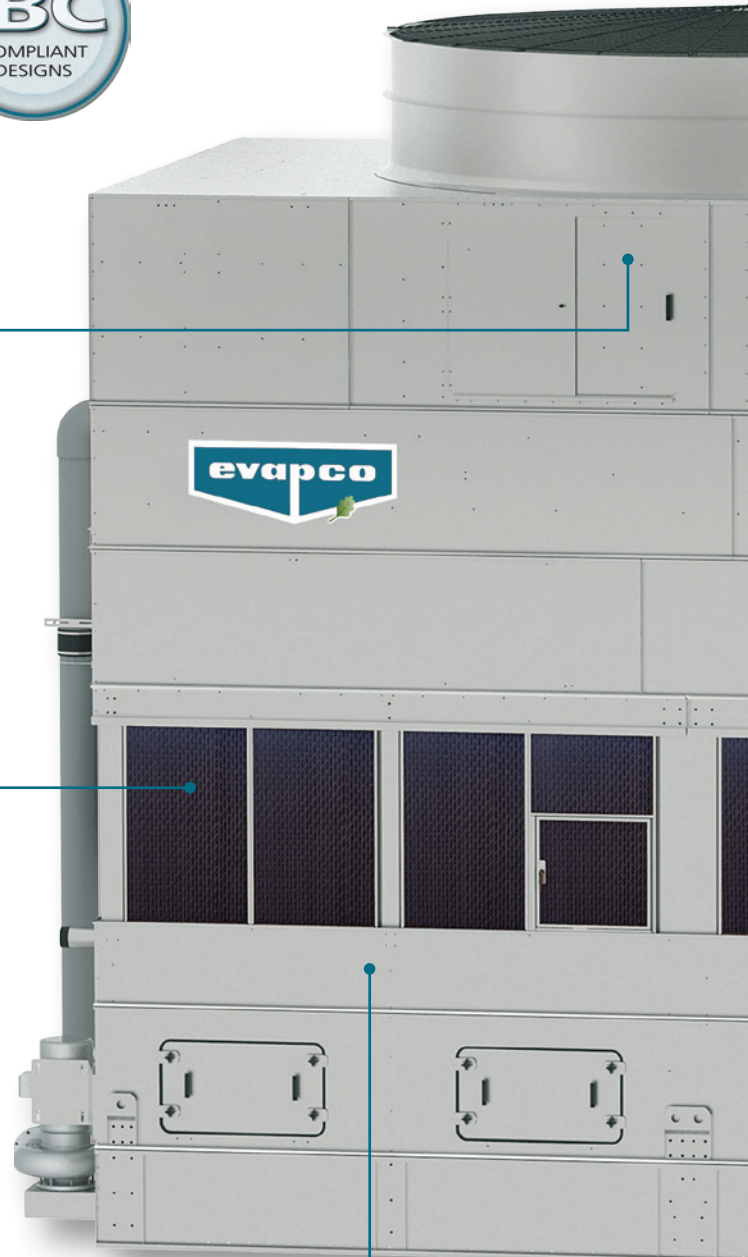

All features available on all ESW4 Models unless specified

† Mark owned by the Cooling Technology Institute

Super Low Sound Fan

The ESW4 is available with Low Sound Solutions to reduce the overall sound generated from the top of the already quiet ESW4 Closed Circuit Cooler. Each option provides various levels of sound reduction and can be combined to provide the lowest sound level available on a closed circuit cooler.

- Select a Super Low Sound Fan for a 9 to 15 dB(A) reduction
- Select a Low Sound Fan for a 4 to 7 dB(A) reduction

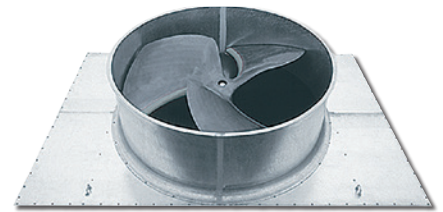

Pressurized Water Distribution System

- Evapjet™ nozzles provide thermal performance gain
- Non-corrosive PVC construction
- Large orifice nozzles prevent clogging and are threaded for easy removal and positive positioning
- Each nozzle provides a large uniform spray pattern



EVAPAK® Fill

- Induces highly turbulent mixing of the air and water for superior heat transfer
- Special drainage tips allow high water loading without excessive pressure drop
- Flame spread rating less than 25 per ASTM E-84
- Can be used as an internal working platform

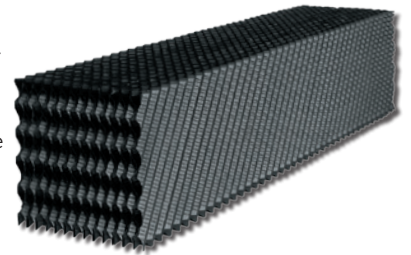

Galvanized Steel Coil

Elliptical Sensi-Coil® Featuring CROSSCOOL Internal Tube Enhancement Technology

- Internal Tube Enhancement increases fluid turbulence providing additional capacity
- Elliptical return bends allows for more circuits per coil bundle increasing maximum capacity per footprint
- Coil located out of airstream eliminating water evaporation on the coil, reducing scale buildup potential
- Optional Type 304L and 316L Stainless Steel Coil Available

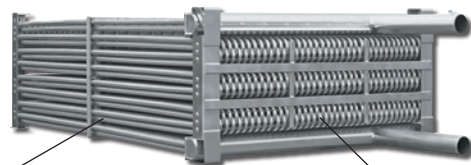

Most Accessible Basin and Coil

- Convenient side access from ground level
- Large open area simplifies maintenance
- Easy access to basin floor, float assembly and pump strainer

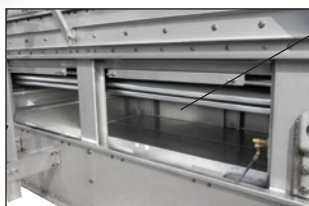

CROSSCOOL™
INTERNAL TUBE ENHANCEMENT

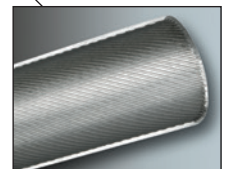

PHW Design and Construction Features - Double Air Inlet Models



PVC Spray Distribution Header with ZM® II Nozzles

- Large orifice nozzles prevent clogging (no moving parts)
- Designed for superior water distribution
- Threaded nozzles eliminate troublesome grommets
- Fixed position nozzles require zero maintenance
- Threaded end caps for ease of cleaning
- Guaranteed for life

Galvanized Steel Coil

Elliptical Sensi-Coil®** Featuring **CROSSCOOL** Internal Tube Enhancement Technology

- Internal Tube Enhancement increases fluid turbulence providing additional capacity
- Elliptical return bends allows for more circuits per coil bundle increasing maximum capacity per footprint

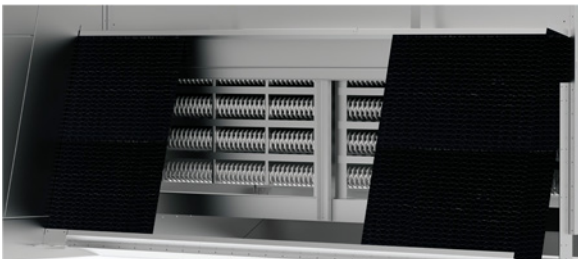

Efficient Drift Eliminators

- Patented design reduces drift rate
- Made from corrosion-resistant PVC for long life

Double-Brake Flange Joints

- Stronger than single-brake design
- Minimizes water leaks at field joints
- Greater structural rigidity

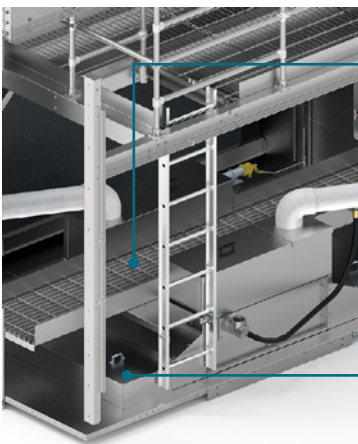

Internal Walkway

- For safe easy access to entire basin

Pump House Access

- Easy access to pump and pump motor
- Oversized for easy addition of accessories, i.e. pan heaters

Stainless Steel Strainer

- Resists corrosion better than other materials

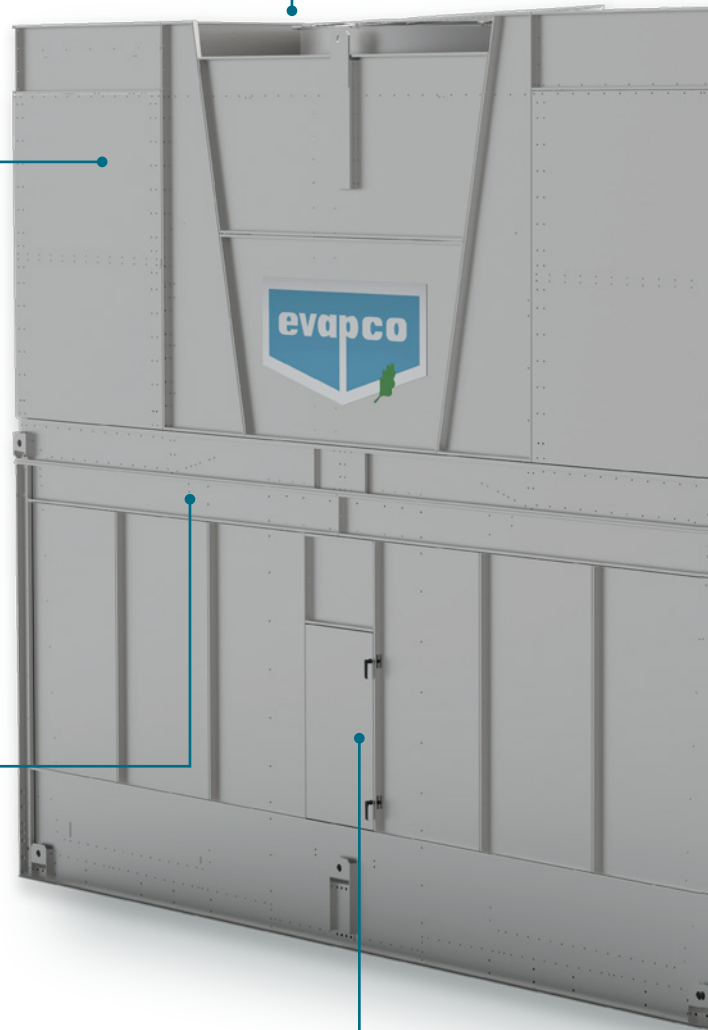

Large Access Door

- Oversized access door for enhanced accessibility
- Standard on all models

Totally Enclosed Pump Motors

- Long, trouble-free operation

Z-725 Mill Hot-Dip Galvanized Steel Construction

(Stainless steel available as affordable option)

Advanced Design Smooth Flow Fan System

- Totally enclosed fan motors assures long life
- Power-Band belts for better lateral rigidity
- Advanced design aluminum fan blades
- Non-corroding cast aluminum sheaves
- Heavy-duty fan shaft bearings with L_{10} life of 100,000 hou

Sun-Blocker System (Optional)

- Blocks sun light to minimize potential algae formation
- Prevents debris from entering the unit
- Eliminates water splash out



Easy Rig Field Seam

- Self-guiding channels improve the quality of the field seam to eliminate leaks
- Easy to install
- Lower installation cost

External Service Platform with Ladder (Optional)

- Safe access to coil
- Self-supporting
- Modular design for easy field installation



XPak™ Crossflow Fill

- High efficiency bonded block fill
- Polyvinyl Chloride (PVC)
- Impervious to rot, decay and biological attack
- Integral louvers and drift eliminators
- Easy to handle
- Flame Spread rating of <25 per ASTM E84

Other PHW Double Air Inlet Options

- Internal motor davit
- Internal upper access ladder & platform
- Low Sound Fan
- Super Low Sound Fan



LSWE Design & Construction Features

EVAPCO's LSWE Closed Circuit Coolers utilize Evapco's Thermal-Pak® coil design now featuring the revolutionary CrossCool™ Internal Tube Enhancement. The Internal Tube Enhancement increases the internal heat transfer coefficient of the coil and thus increases the cooling capacity of the unit. This new and improved series of coolers is the ideal solution for indoor application, confined layouts, low sound requirements and direct replacements to name a few. The LSWE is designed for easy maintenance and long, trouble free operation.

Galvanized Steel Coil Elliptical Thermal-Pak® COIL Construction Featuring **CROSSCOOL™** Internal Tube Enhancement Technology

- Internal tube enhancement increases fluid turbulence providing **additional evaporative capacity**
- Elliptical return bends allows for more circuits per coil bundle increasing maximum capacity per footprint
- Coil located in the airstream increasing dry bulb switchover temperature

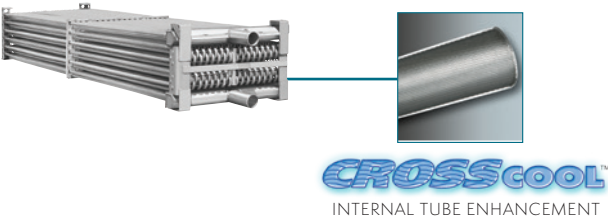

Clean Pan Design

- Sloped design allows water to drain completely from cold water basin
- Easier removal of dirt and debris



Easy Field Assembly

- Ensures easy assembly and fewer fasteners
- Incorporates self-guiding channels to guide the coil casing section into position improving the quality of the field seam



Optional Factory Mounted Non-Chemical or Chemical Water Treatment Systems

Zero Maintenance PVC Spray Distribution Header with ZM®II Nozzles

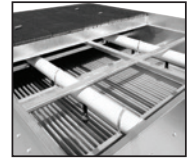

Eurovent-CTI Certified Units



† Mark owned by the Cooling Technology Institute

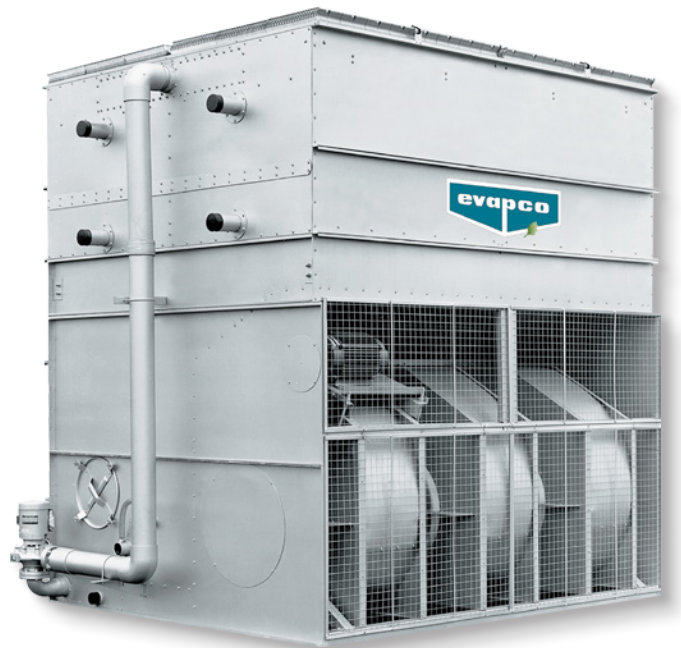

Factory Mutual Approved

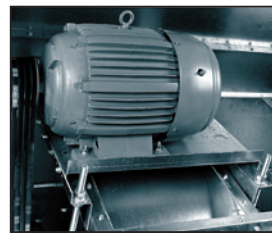

Totally Enclosed Fan Motors

- Assures long life
- All normal maintenance can be performed quickly from outside the unit
- If required, motor may be easily removed
- Premium efficient inverter-ready motors are standard

LRWB Design & Construction Features

EVAPCO's LRWB Closed Circuit Coolers utilize Evapco's Thermal-Pak® coil design now featuring the revolutionary CrossCool™ Internal Tube Enhancement. The Internal Tube Enhancement increases the internal heat transfer coefficient of the coil and thus increases the cooling capacity of the unit. This new and improved series of coolers is the ideal solution for indoor application, confined layouts, low sound requirements and direct replacements to name a few. The LRWB is designed for easy maintenance and long, trouble free operation.

Galvanized Steel Coil Elliptical Thermal-Pak® COIL Construction Featuring **CROSSCOOL™ Internal Tube Enhancement Technology**

- Internal tube enhancement increases fluid turbulence providing **additional evaporative capacity**
- Elliptical return bends allows for more circuits per coil bundle increasing maximum capacity per footprint
- Coil located in the airstream increasing dry bulb switchover temperature

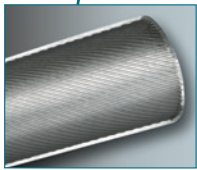
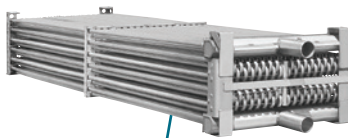

CROSSCOOL™
INTERNAL TUBE ENHANCEMENT

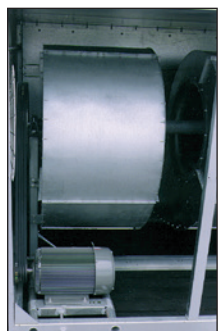

Easy to Service Motor & Drive System

- Belt tensioning and bearing lubrication can be performed from outside the unit
- Locking mechanism can also be used as a wrench to adjust the belts
- Motor is fully accessible by removing one inlet screen
- Split fan housings allow removal of all mechanical equipment through the end of the unit

Zero Maintenance PVC Spray Distribution Header with ZM®II Nozzles

- Fixed position nozzles require zero maintenance
- Large orifice nozzles prevent clogging

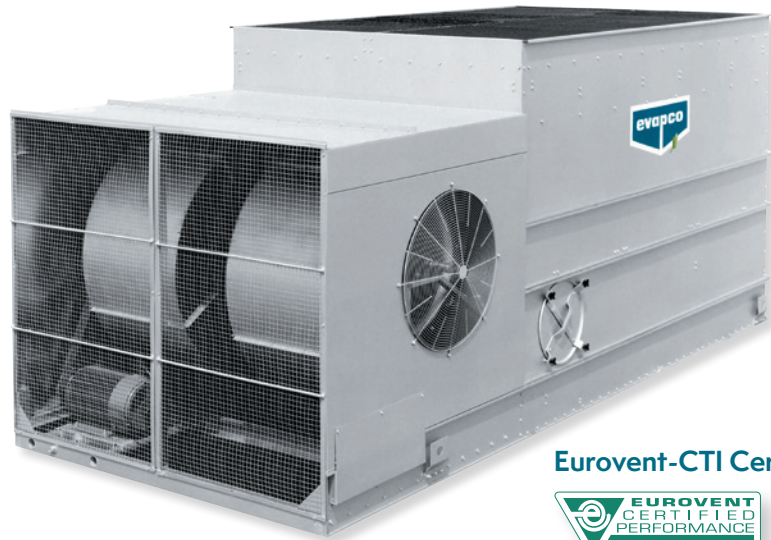

Eurovent-CTI Certified Units



† Mark owned by the Cooling Technology Institute

Fan Housing

- Standard on all LR series selections
- Drive system is completely enclosed in a protective housing
- First stage sound attenuation, providing sound reduction



Optional Factory Mounted Non-Chemical or Chemical Water Treatment Systems

eco-ATWB Design & Construction Features

The eco-ATWB line of closed circuit coolers has been specifically designed to dramatically increase both the evaporative (latent) and dry (sensible) modes of cooling. With this revolutionary design, the EVAPCO eco-ATWB will also save water and energy by increasing the unit's efficiency in both the evaporative and dry cooling modes of operation. The eco-ATWB utilizes the EVAPCO Ellipti-fin® coil which features elliptical spiral fin technology to maximize the surface area available for heat transfer. The Ellipti-fin® coil now features CrossCool™ Internal Tube Enhancement which increases the internal heat transfer coefficient of the coil and thus increases the cooling capacity of the unit. The eco-ATWB is the ideal solution for: reducing water consumption, lowering energy costs, increasing the dry-bulb switchover, and maintaining super low sound levels. This product is designed with IBC Compliant construction and Eurovent-CTI Certified Performance.

Ellipti-fin®

Galvanized Steel Elliptical Spiral Fin Coil featuring CROSSCOOL™ Internal Tube Enhancement Technology

- The most efficient closed circuit cooler coil in the HVAC industry!
- **30% AND MORE ADDITIONAL** evaporative capacity and HIGHER dry-bulb switchover temperatures
- All coil rows feature EVAPCO's patented finned Thermal-Pak® elliptical tube design
- Elliptical tube design results in lower airflow resistance than typical finned round tubes

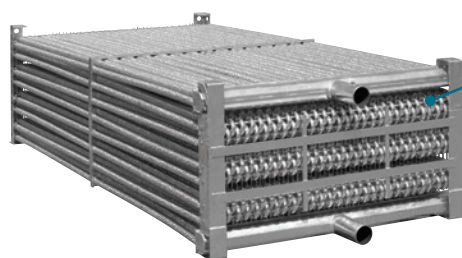

Optional Factory Mounted Non-Chemical or Chemical Water Treatment Systems

The eco-ATWB is available with either a **Pulse-Pure®** non-chemical or a **Smart Shield®** solid chemical water treatment system. The **Pulse-Pure®** and **Smart Shield®** are environmentally sensitive alternatives for treating water in evaporative cooled equipment. The **Pulse-Pure®** and **Smart Shield®** systems include all components required for an effective water treatment system; factory mounted and wired.



Most Accessible Basin

- Access from all four sides
- Large open area simplifies maintenance
- Basin may be inspected with pumps running



Louver Access Door

- Louver access door is available on models with 1.5 and 1.8 m tall louver sizes
- Hinged access panel with quick-release mechanism
- Allows easy access to perform routine maintenance and inspection of the makeup assembly, strainer screen and basin



Super Low Sound Fan

- Extremely wide sloped fan blades for sound sensitive applications
- Molded heavy-duty construction
- 9-15 dB(A) sound reduction



Factory Mutual Approved



Fan Drive System

- Power-Band belts for better lateral rigidity
- Advanced design aluminum fan blades
- Non-corroding cast aluminum sheaves
- Heavy-duty fan shaft bearings with L₁₀ life of 100,000 hrs.
- All other components constructed of corrosion resistant materials
- Totally enclosed fan motors assure long life



Efficient Drift Eliminators

- Advanced design minimizing drift from the leaving airstream
- Made from corrosion resistant PVC for long life

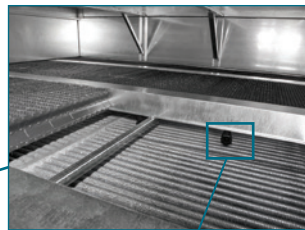

PVC Spray Distribution Header with ZM™II Nozzles

- Large orifice fixed-position nozzles prevent clogging

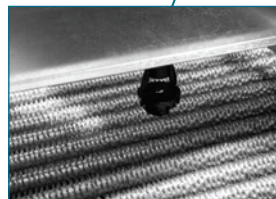

Eurovent-CTI Certified Units



† Mark owned by the Cooling Technology Institute

WST II Air Inlet Louvers (Water and Sight Tight)

- Easily removable for access
- Improved design to keep sunlight out—preventing biological growth
- Keeps water in while keeping dirt and debris out



eco-ATWB-H Design & Construction Features

The eco-ATWB-H Hybrid line of closed circuit coolers was designed with the purpose of providing maximum water savings, higher dry-bulb switchover temperatures, while achieving plume abatement or elimination. The eco-ATWB-H is provided with EVAPCO's ARID fin Pak™ dry coil. Utilizing stainless steel tubes and aluminum manganese fins, the ARID fin Pak™ maximizes the total surface area available for sensible heat transfer, which results in maximum water savings and higher dry bulb switchover temperatures. Additionally, the eco-ATWB-H is provided with the highly efficient Ellipti-fin® coil in series with the ARIDfin Pak™, achieving both latent and sensible cooling simultaneously. The Ellipti-fin® now features CrossCool™ Internal Tube Enhancement which increases the internal heat transfer coefficient of the coil and thus increases the cooling capacity of the unit. Located in the discharge airstream, the ARID fin Pak™ heats the saturated discharge air, abating or eliminating plume. Because the coils are in series, a significant portion of the heat load will always be dissipated through the dry cooling coil, saving water whenever it is in operation! The eco-ATWB-H is the ideal solution for: maximizing water savings, increasing drybulb switchover temperature(s), and providing plume reduction or plume abatement. This product is designed with IBC Compliant construction and Eurovent-CTI Certified Performance.

Eurovent-CTI Certified Units



† Mark owned by the Cooling Technology Institute



Optional Factory Mounted Non-Chemical or Chemical Water Treatment Systems



Efficient Drift Eliminators

- Advanced design minimizing drift from the leaving airstream
- Made from corrosion-resistant PVC for long life



Super Low Sound Fan

- Extremely wide sloped fan blades for sound sensitive applications
- Molded heavy-duty construction
- 9-15 dB(A) sound reduction

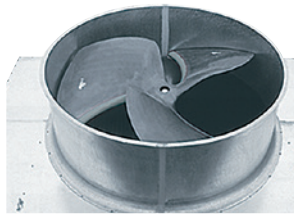

ARID *fin Pak*™

Dry Cooling Coil

Featuring Stainless Steel Tubing with Aluminum Fins

- Maximizes water efficiency
- Higher dry-bulb switchover temperatures
- Plume elimination in dry mode
- Plume abatement in evaporative mode
- Increases evaporative and dry cooling efficiency

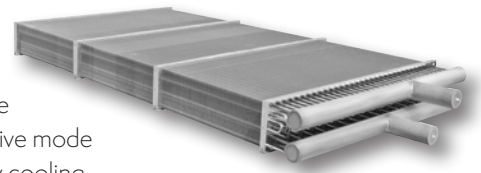

Ellipti-*fin*®

Galvanized Steel Elliptical Spiral Fin Coil featuring **CROSSCOOL**™ Internal Tube Enhancement Technology

- The most efficient closed circuit cooler coil in the HVAC industry!
- **30% AND MORE ADDITIONAL** evaporative capacity and **HIGHER** dry-bulb switchover temperatures
- All coil rows feature EVAPCO's patented finned Thermal-Pak® elliptical tube design
- Elliptical tube design results in lower airflow resistance than typical finned round tubes

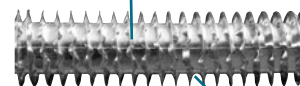
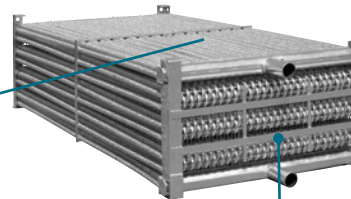

Ellipti-*fin*®
EXTERNAL TUBE FIN

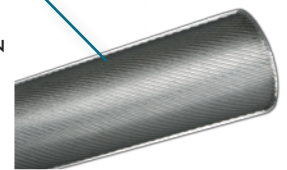

CROSSCOOL™
INTERNAL TUBE ENHANCEMENT

Factory Mutual Approved



eco-LSWE Design & Construction Features

Featuring EVAPCO's revolutionary coil with CrossCool™ Internal Tube Enhancement, the eco-LSWE closed circuit cooler is the most energy and water efficient forced draft cooler available in the industry. This new and improved series of coolers is the ideal solution for indoor applications, confined layouts, low sound requirements and direct replacements to name a few. NOW, with EVAPCO's state-of-the-art Ellipti-fin® spirally finned, internally enhanced coil technology, the eco-LSWE can replace existing forced draft equipment of the same boxsize and fan motor horsepower and provide up to an ADDITIONAL 30% in thermal capacity!!

Ellipti-fin®

Galvanized Steel Elliptical Spiral Fin Coil featuring **CROSSCOOL™** Internal Tube Enhancement Technology

- The most efficient closed circuit cooler coil in the HVAC industry!
- **30% AND MORE ADDITIONAL** evaporative capacity and HIGHER dry bulb switchover temperatures
- All coil rows feature patented finned Thermal-Pak® elliptical tube design
- Elliptical tube design results in lower airflow resistance than typical finned round tubes

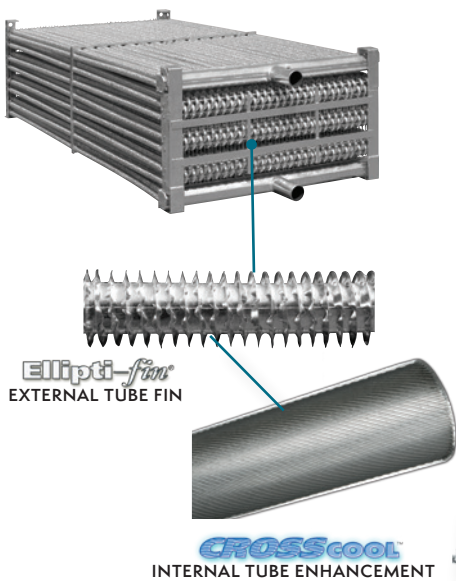

Optional Factory Mounted Non-Chemical or Chemical Water Treatment Systems

Eurovent-CTI Certified Units



† Mark owned by the Cooling Technology Institute

Zero Maintenance PVC Spray Distribution Header with ZM®II Nozzles

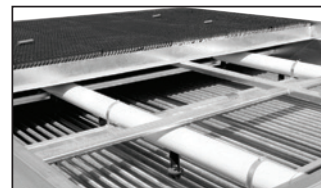

Factory Mutual Approved



Easy Field Assembly

- Ensures easy assembly and fewer fasteners
- Incorporates self-guiding channels to guide the coil casing section into position improving the quality of the field seam



Clean Pan Design

- Sloped design allows water to drain completely from cold water basin
- Easier removal of dirt and debris

Totally Enclosed Fan Motors

- Assures long life
- All normal maintenance can be performed quickly from outside the unit
- If required, motor may be easily removed



eco-LRWB Design & Construction Features

Featuring EVAPCO's revolutionary coil with CrossCool™ Internal Tube Enhancement, the eco-LRWB closed circuit cooler is the most energy and water efficient forced draft cooler available in the industry. This new and improved series of coolers is the ideal solution for indoor applications, confined layouts, low sound requirements and direct replacements to name a few. NOW, with EVAPCO's state-of-the-art Ellipti-fin® spirally finned, internally enhanced coil technology, the eco-LRWB can replace existing forced draft equipment of the same boxsize and fan motor horsepower and provide up to an ADDITIONAL 30% in thermal capacity!!

Ellipti-fin®

Galvanized Steel Elliptical Spiral Fin Coil featuring CROSSCOOL™ Internal Tube Enhancement Technology

- The most efficient closed circuit cooler coil in the HVAC industry!
- **30% AND MORE ADDITIONAL** evaporative capacity and HIGHER dry bulb switchover temperatures
- All coil rows feature patented finned Thermal-Pak® elliptical tube design
- Elliptical tube design results in lower airflow resistance than typical finned round tubes

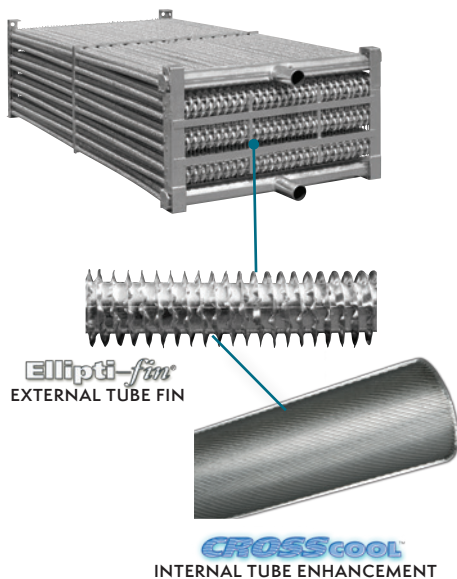

Optional Factory Mounted Non-Chemical or Chemical Water Treatment Systems

Eurovent-CTI Certified Units



† Mark owned by the Cooling Technology Institute

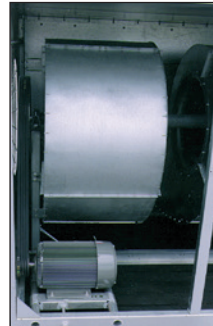

Easy to Service Motor & Drive System

- Belt tensioning and bearing lubrication can be performed from outside the unit
- Locking mechanism can also be used as a wrench to adjust the belts
- Motor is fully accessible by removing one inlet screen
- Split fan housings allow removal of all mechanical equipment through the end of the unit

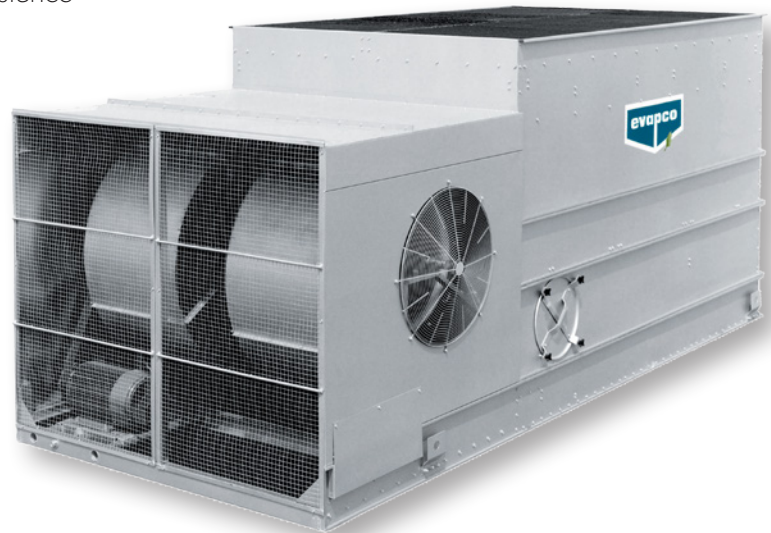

Fan Housing

- Standard on all LR series selections
- Drive system is completely enclosed in a protective housing
- First stage sound attenuation, providing sound reduction

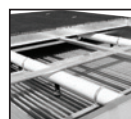

Zero Maintenance PVC Spray Distribution Header with ZM® II Nozzles

- Fixed position nozzles require zero maintenance
- Large orifice nozzles prevent clogging

eco-Air Series™ Design & Construction Features

The eco-Air Series of dry coolers represents EVAPCO's newest advancement in thermal heat transfer research and development. Available in fully dry, adiabatic and spray designs, the eco-Air Series maximizes heat rejection with minimal or no water use. The eco-Air Series is another chapter in EVAPCO's ongoing commitment to high quality, environmentally friendly products.

Structure and Casing

- Standard Z-725 galvanized steel (725 g/m² of zinc)
- Stainless steel 304L/316L available for increased corrosion resistance and longevity

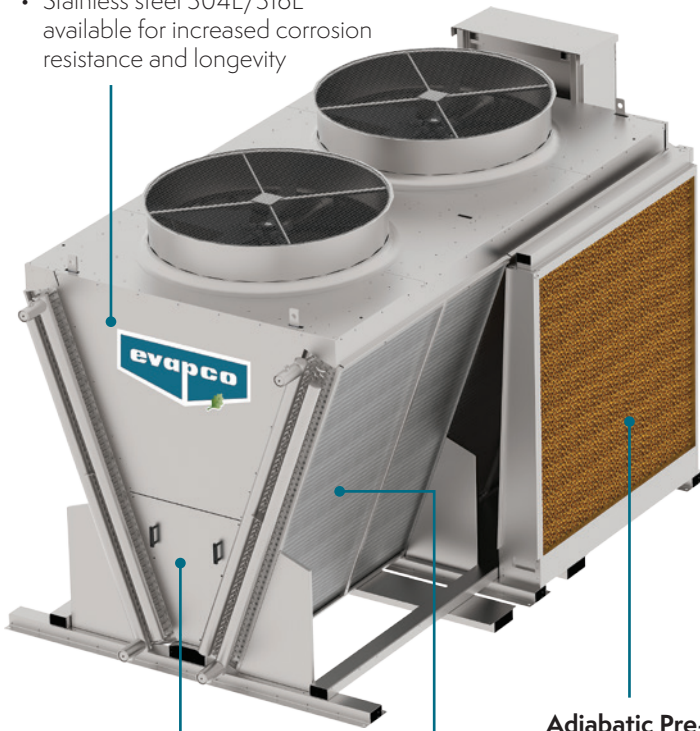

V Coil Models

- Maximum surface area per footprint
- Optimized coil angle for heat rejection and air flow
- Compact plan area and layout

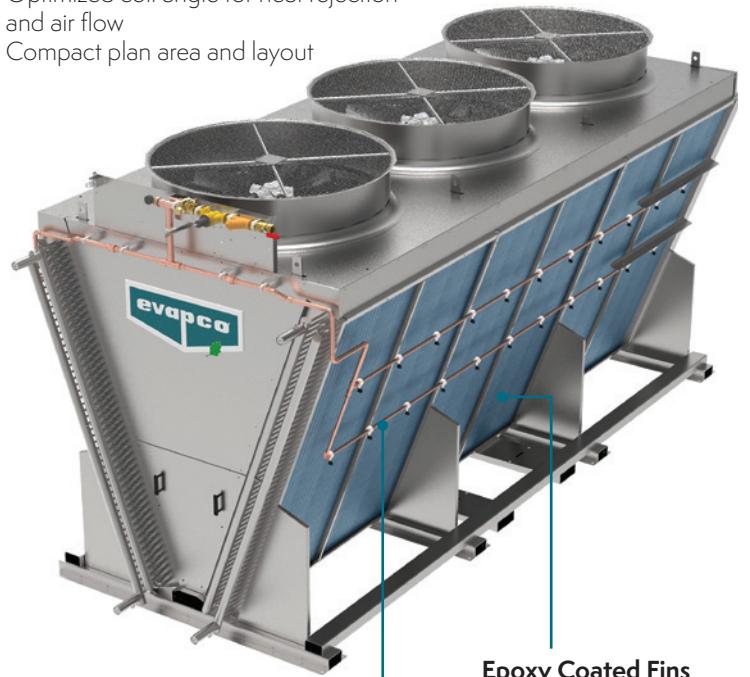

Inspection Panel (V Coil Models)

- Easily removable for interior inspection and access to coils and fan motors



Heat Exchanger Coils

- Stainless Steel tubes with aluminum fins
- Multiple fin spacings and tube configurations
- Upgraded fin thickness available
- Coated aluminum fins available for increased corrosion resistance with no impact on unit performance

Adiabatic Pre-Cooling System (Optional)

- Wetted pads can be utilized to pre-cool entering air, resulting in greater energy savings, and increased capacity, with minimal water use
- Great for high dry bulb climates and high temperature applications
- Once through design
- No water treatment required
- No cold water basin or pump
- No drift
- V coil models only

Spray Assist System (Optional)

- Peak load cooling solution
- Epoxy Coated Fins
- Tangential-flow hollow cone nozzles
- Self-draining copper piping

Coil Return Bend Covers

- Protects the coil return bends during handling and operation

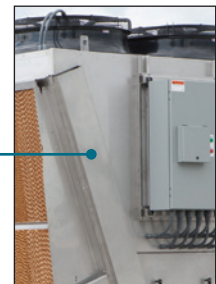

Epoxy Coated Fins

- Standard on Spray Models
- Optional on Dry & Adiabatic Models
- Increased corrosion resistance
- No impact on unit capacity

Internal Step Deck (Optional-V Coil Models)

- Platform and grab rail for access to elevated fan section components (2.4 m wide V Coil Models only)

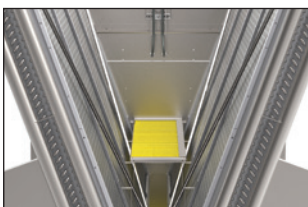

† Mark owned by the Cooling Technology Institute

eco-Air Series Dry Cooler Thermal Performance is CTI certified per Std-201.

Advanced Motor Technology – Electronically Commutated (EC) or AC fan motor designs



EC

- High Efficiency
- Zero Maintenance
- Integral Speed Control
- Inherently Low Sound

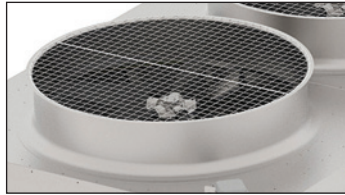

AC

- Premium efficient direct drive
- Zero maintenance sealed bearings
- VFD ready
- Severe Duty

Flat Coil Models

- Low profile design
- Great for elevated installations with bottom airflow clearance

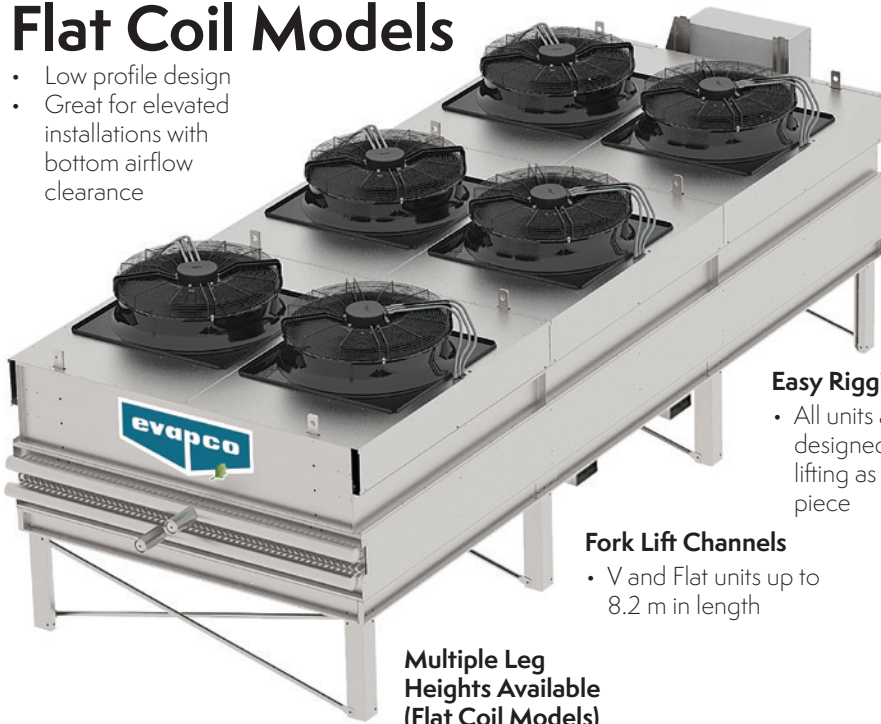

Easy Rigging

- All units are designed for lifting as one piece

Fork Lift Channels

- V and Flat units up to 8.2 m in length

Multiple Leg Heights Available (Flat Coil Models)

Coils Pressurized with Nitrogen

- Limits internal corrosion potential during transport and storage

Common Terminal Box

- All motors factory wired
- Saves time in the field



Factory Mounted & Wired Controls



- EVAPCO PLC Panel (EC Motors)
- EVAPCO PLC/VFD Panel (AC Motors)
- Single point power connection



IBC Compliant Design

- All standard models meet IBC requirements
- Upgraded designs available for high seismic and wind load areas
- Shake table verified for 1.5 Importance Factor installations

Warranty

- 2 years complete unit
- 2 years adiabatic pads (if equipped)
- 2 years spray system (if equipped)
- 2 years EVAPCO Controller and other electrical components (if equipped)



† Mark owned by the Cooling Technology Institute

eco-Air Series Dry Cooler
Thermal Performance is CTI certified per Std-201.

eco-Air Series™ Double Stack Dry & Adiabatic Coolers

The eco-Air Series of Dry & Adiabatic Double Stack coolers are designed to address the market need for higher capacity factory assembled dry coolers with a smaller installed footprint than options currently available in the market. By stacking one section on top of another to maximize surface area available for cooling, the footprint of a project can be effectively halved, therefore simplifying piping and electrical connections and improving access to optimize layout on large projects requiring multiple units.

EVAPCO's dry coolers and the dry performance of adiabatic coolers is now CTI certified per Standard 201, adding further credibility to EVAPCO's 100% thermal performance guarantee.

Drive System Options

AC

- IE3 single speed inverter duty motor compliant with (EC) No 640/2009
- Aluminum low sound fans as standard
- Belt drive
- Motors are factory wired to individual motor safety switches
- Speed control by others

EC

- Highly efficient EC motors
- Integrated fan and motor assemblies
- Factory wired by EVAPCO to a PLC control panel
- Unit can control itself or accept external communication from BMS



Adiabatic Pre-cooling Media

- High efficiency adiabatic pre-cooling pads
- No water treatment required
- No drift
- No recirculation pump required

Adiabatic Water Distribution System

- Copper distribution piping
- 2 stage water system for increased water savings
- Pressure gauge
- Water pressure regulator
- Strainer
- Make up connection
- Drain valve

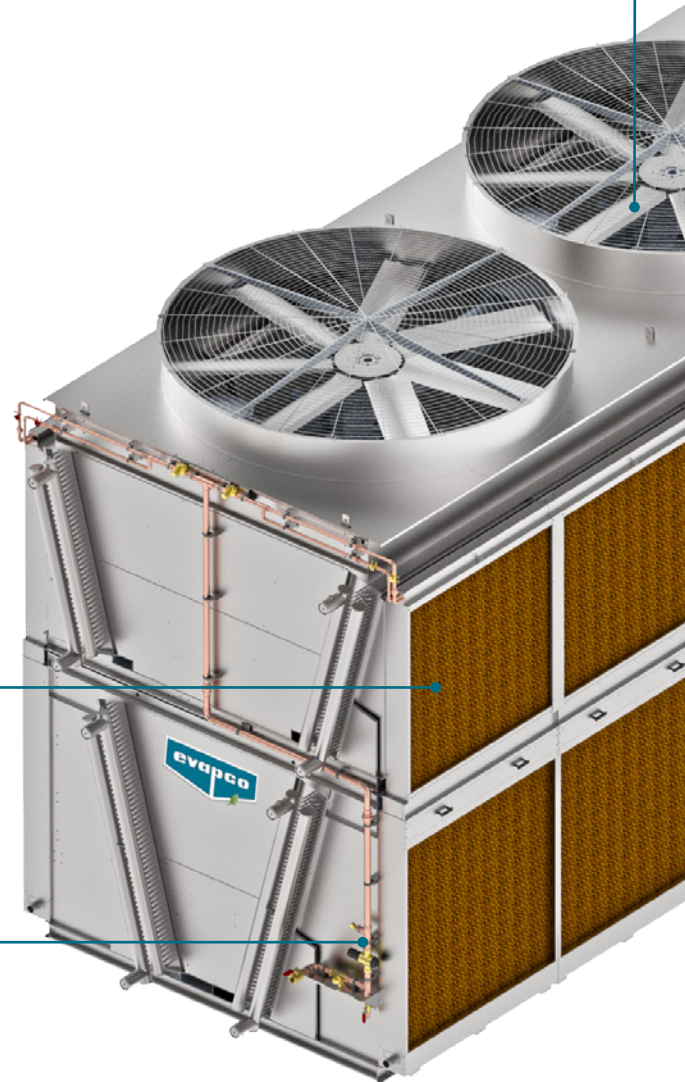

No Plume

- eco-Air Dry & Adiabatic units are 100% plume free



Electrical Termination Enclosures

- Individual motor safety switches for AC motor units
- PLC panels for EC motor units
- Low voltage terminal box for adiabatic system solenoid valves and vibration switches

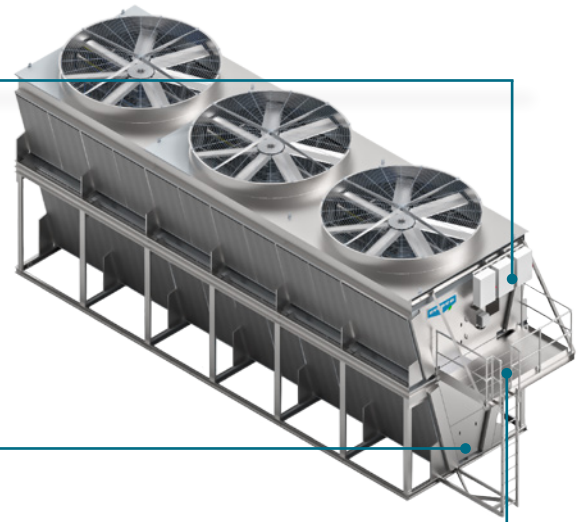

Inspection Panel

- Easily removable for interior inspection and access to coils and fan motors

External Service Platform with Ladder

- Optional feature can be added to any installation

Warranty

- 2 years for the complete unit (including drive system and heat exchanger coils)
- 2 years for the adiabatic pads (if equipped)
- 2 years for the electrical components



Structure and Casing

- Standard Z-725 galvanized steel (725 g/m² of zinc)
- Type 304L stainless steel available for increased corrosion resistance and longevity

Heat Exchanger Coils

- Type 304L stainless steel coils
- Multiple fin spacings & circuiting configurations
- Heavy gauge aluminum fins
- Optional upgrade to epoxy-coated fins for increased corrosion resistance with no impact on unit performance



† Mark owned by the Cooling Technology Institute

eco-Air Series Dry Cooler
Thermal Performance is CTI certified per STD-201.



Pulse~Pure® Non-Chemical Water Treatment System

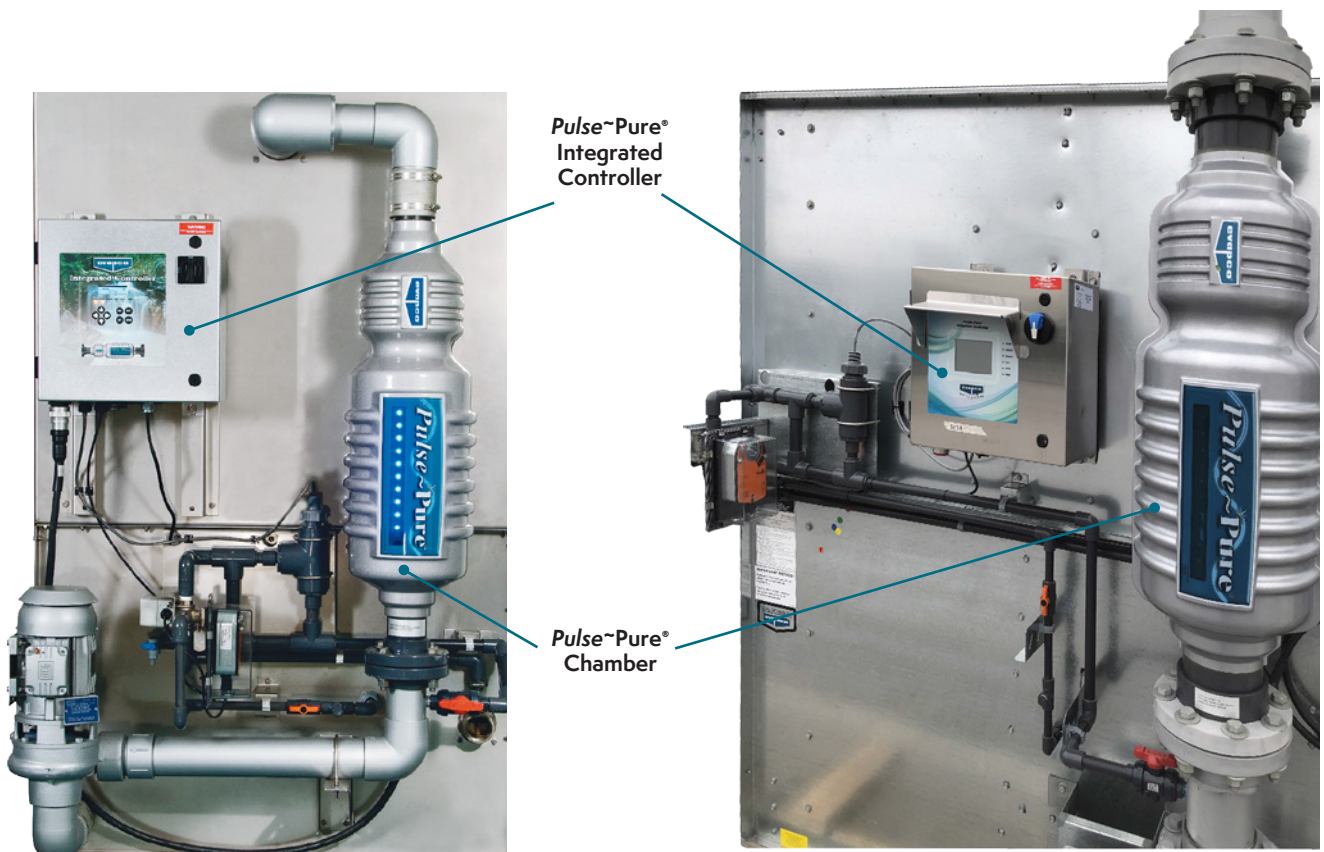

EVAPCO's **Pulse~Pure**® water treatment system utilizes pulsed electric field technology to provide an environmentally responsible alternative for the treatment of water in evaporative cooling equipment. The **Pulse~Pure**® system delivers short low- and high-frequency bursts of electromagnetic fields to the recirculating water in the fluid cooler.

- EVAPCO guarantees that total bacterial counts will not exceed 10,000 CFU/ml in the cooling water
- Controls scale, corrosion, and microbiological growth with absolutely no chemicals required
- Compact design with no moving parts and low energy consumption



Smart Shield® Solid Chemical Water Treatment System

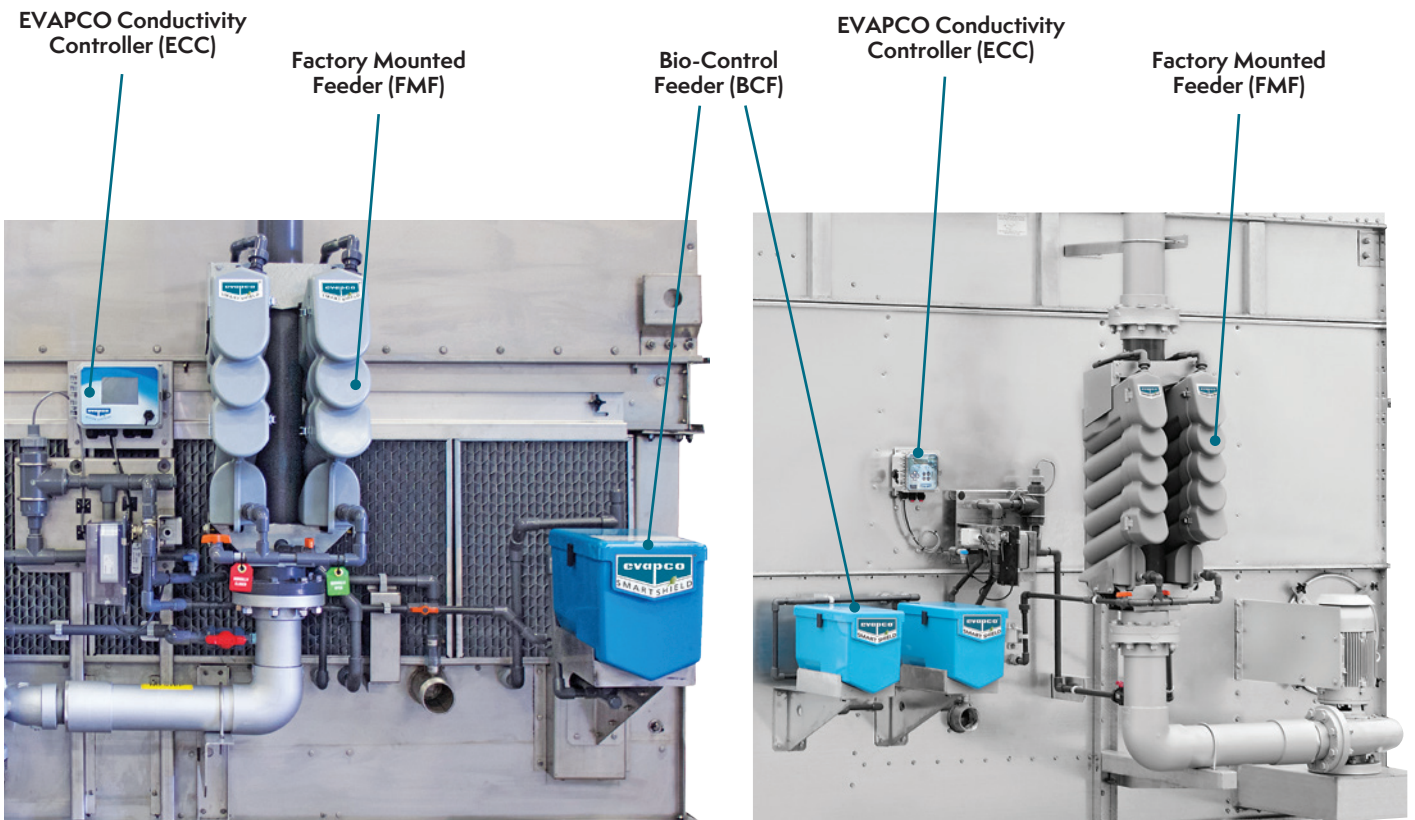

EVAPCO's **Smart Shield**® system utilizes proven solid chemistry delivered via our revolutionary feed system. With patented Controlled Release tablets, a scale and corrosion inhibitor is fed whenever your spray water pump is energized. Thus keeping your system protected anytime the spray water pump is operating.

Smart Shield® is a complete water treatment package that:

- Utilizes 'Bag in Bag' no touch chemical replenishments, making reloads easier and safer
- Creates reduced packaging, shipping and handling, providing a reduced carbon footprint compared to liquid chemicals
- Eliminates the hazards associated with liquid chemicals, potential for liquid spills, and the need for expensive feed pumps—making it the easiest and safest chemical water treatment system available today

Heat Transfer Media

EVAPAK® Fill (ESW4 Only)

Our EVAPAK® fill is specially designed to induce a highly turbulent mix of air and water for superior heat transfer. EVAPAK® ESW4 fill is constructed of inert polyvinyl chloride (PVC), so it will not rot or decay. The bottom support of the fill section, combined with the unique way in which EVAPAK® counterflow fill's cross-fluted sheets are bonded together, greatly enhances the fill's structural integrity, making it usable as a working platform.

EVAPAK® is also self-extinguishing with a flame spread rating of <25 per ASTM-E84. The ESW4 is the only closed circuit cooler that utilizes fill inside the unit.

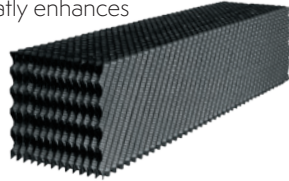

Galvanized Steel Coil

Sensi-coil® (ESW4)

The ESW4 Closed Circuit Cooler utilizes EVAPCO's Sensi-Coil®, featuring CrossCool™ Internal Tube Enhancement. The Sensi-Coil® provides the maximum amount of elliptical tubes packed closely together in a coil arrangement designed with over 50% additional coil surface area. With the Sensi-Coil® located below the air stream on the ESW4, 100% sensible heat transfer is occurring through the coil surface, minimizing potential scaling.

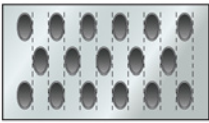

EVAPCO's Sensi-Coil®

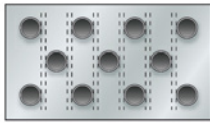

Round Tube Coil by Others



EVAPCO's Thermal-Pak® Elliptical Tube

Thermal-Pak® II (ATWB, LSWE, LRWB)

The ATWB, LSWE, and LRWB closed circuit coolers utilize EVAPCO's Thermal-Pak® coil design. The elliptical tube design allows for closer tube spacing, resulting in greater surface area per plan area than round-tube coil designs. In addition, the Thermal-Pak® design has lower resistance to airflow and also permits greater water loading making the Thermal-Pak® coil the most efficient design available. The Thermal-Pak® coil design also features EVAPCO's CrossCool™ Internal Tube Enhancement Technology. This increases fluid turbulence through the coil, further increasing the evaporative capacity.

Ellipti-fin® (eco-ATWB/-E/-H, eco-LSWE, eco-LRWB)

The eco-Cooler line of closed circuit coolers utilize EVAPCO's patented Ellipti-fin® coil design, featuring internal tube enhancement ensures even greater operating efficiency. The elliptical tube design allows for closer tube spacing, resulting in greater surface area per plan area than round-tube coil designs. In addition, the revolutionary Ellipti-fin® design uses elliptical spiral fin coil technology and has lower resistance to air flow than typical finned coil designs. This permits greater

water loading and increases the evaporative and dry cooling capacity of the coil. EVAPCO's CrossCool™ internal tube enhancement increases fluid turbulence through the coil, further increasing the evaporative capacity. The Ellipti-fin® coil is the most efficient design available in the industry, providing up to 30% ADDITIONAL evaporative capacity in the same box!

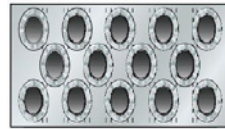

EVAPCO's Ellipti-fin® Finned

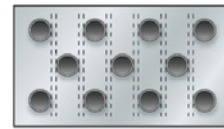

Round Tube Coil by Others

Stainless Steel Coil

Evaporative Units

EVAPCO offers optionally stainless steel 304L and 316L coils manufactured using EVAPCO's patented elliptical tube Sensi-Coil®.



Note: Units constructed with ellipti-fin do NOT have a stainless steel coil option.

eco-Hybrid

The eco-ATWB-H Closed Circuit Cooler utilizes the ARID fin Pak™ Dry Cooling Coil. Installed in the air discharge of the cooler the ARID fin Pak™ dry cooling coil is piped in series with the evaporative cooling coil. The ARID fin Pak™ dry cooling coil is constructed of 304L stainless steel tubes and tubular stainless steel header with carbon steel coil connections for easy field piping. The fins have fully drawn collars to maintain consistent fin spacing and continuous surface contact over the entire tube to maximize heat transfer. The fins are constructed of an aluminum/manganese alloy for superior corrosion resistance.

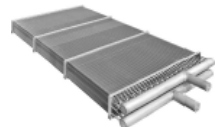

eco-Air Series

Eco-Air Series dry and adiabatic coolers are constructed with high-grade Type 304L stainless steel tubing and aluminum fins as standard. The stainless steel tubing meets the requirements of ASME B31.5 piping code.

The tubing is roll formed and continuously welded, annealed, and tested using an eddy current device. The round tubing is fit into the aluminum fin plate and hydraulically expanded. This procedure provides more consistent contact between the tube and the fin plate than mechanical expansion. The entire coil is then pressure tested to 110% of design working pressure. Lastly, the coil is dried, evacuated, and charged with low pressure nitrogen prior to shipment. 316L stainless steel tubing is available. For applications where corrosion of the aluminum fin is a concern, EVAPCO offers coated aluminum fins.

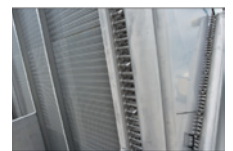

EVAPCO is committed to using only the highest quality, industrial grade materials in all our closed circuit coolers ensuring absolute reliability and longevity.

Polyvinyl Chloride (PVC)

Schedule 40 piping is utilized for our pressurized water distribution for superior corrosion resistance and to minimize water distribution maintenance required. Fill media is constructed of PVC with a cross-fluted design and is resistant to rot, decay and biological attack.

7-725 Galvanized Steel

Our closed circuit coolers utilize heavy gauge mill hot-dip galvanized steel. All galvanized steel is coated with a minimum of 725 g zinc/m² (Z-725 Hot-Dip Galvanized Steel designation). During fabrication, all exposed galvanized steel panel edges are coated with 95% pure zinc-rich compound.



304L Stainless Steel

Our closed circuit coolers may be upgraded to 304L stainless steel. High levels of chromium and nickel allow stainless steel to form a renewable chromium-oxide layer. This ultra-thin layer protects wetted areas, such as the cold and hot water basins from general corrosion. The higher chromium and nickel content greatly impact corrosion resistance properties. Welded cold water basins come standard on our closed circuit coolers with a 304L stainless steel cold-water basin.

316L Stainless Steel

316L stainless steel is the superior material choice for the closed circuit cooler market. It is comprised of 2-3% molybdenum, which gives the surface film a high degree of protection against chloride attack. For coastal regions, high temperature applications, and/or areas with high chloride concentration in the makeup water, this advantage is ideal. Using this material can increase the longevity of your closed circuit cooler and help protect the cooler's integrity in harsh environments. Welded basins come standard on our closed circuit coolers with a 316L stainless steel water basin.

The table below summarizes the metallurgy of common stainless-steel options.

Type	Chromium Content wt%	Nickel Content wt%	Molybdenum Content wt%	Carbon Content wt%
304L	18.0 - 20.0	8.0 - 12.0	0.00	0.03
316L	16.0 - 18.0	10.0 - 14.0	2.0 - 3.0	0.03

Low Sound Solutions

Super Low Sound Fan (Optional)

When you're tasked with achieving the lowest sound levels possible, there's only one choice: the EVAPCO Super Low Sound Fan. It's the quietest, most noise-efficient fan in the industry. Made of heavy-duty reinforced polyester, the ultra-wide chord blades have a forward swept design and rounded edges to minimize the sound caused by flow separation and vortex shedding. The end result is a sound pressure level 9 to 15 dB(A) lower than standard fans, depending on the specific unit selection and measurement location, with **no impact on thermal capacity.**

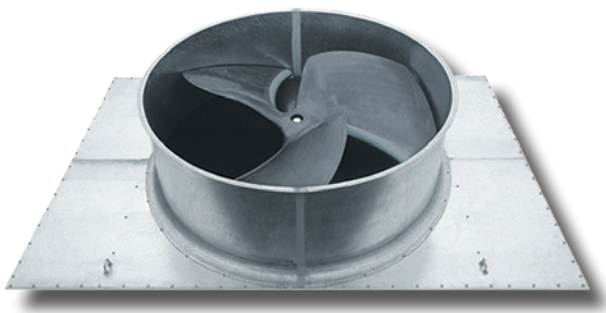

Water Silencer – Reduces Water Noise up to 7 dB(A) (Optional)

Located in the cold water basin, EVAPCO's water silencer reduces the high frequency noise associated with falling water and is capable of lowering overall sound levels 4 to 7 dB(A) when measured at 5 feet from the side or end of the unit. When water is circulated with fans off, the results are even greater: as much as 9 to 12 dB(A) lower at the same measured distance (depending on water loading and louver height). Constructed of lightweight PVC sections, the silencer can be easily removed for access to the basin area. It will have no impact on thermal performance and is CTI certified.

Note: Not available on 1.2 m wide models.

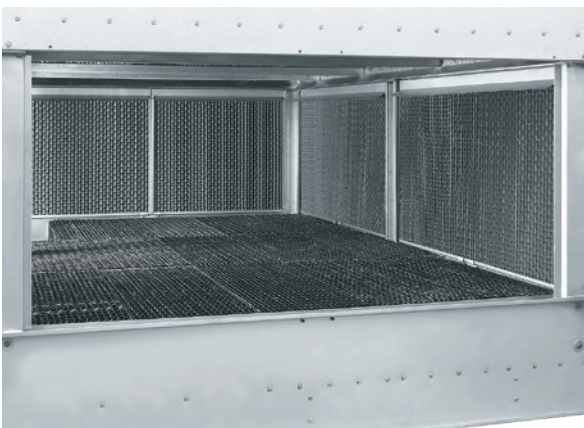

Forced-Draft Sound Attenuation (Optional)

EVAPCO's forced-draft coolers feature a centrifugal fan design that operates at lower sound levels, making the units ideal for installations where noise is a concern. The unit's design can be customized with a variety of intake stages and discharge attenuation packages to greatly reduce sound levels even further for extremely noise sensitive applications.



Offset Sound Attenuation Walls (Optional)

Add EVAPCO's CTI-certified offset sound attenuation walls to your super low sound fan and water silencer options for the ultimate sound control. Constructed of Z-725 galvanized steel and lined inside with acoustical padding, the walls will typically reduce the 15 m free-field sound level by an additional 3 dB(A). Stainless steel construction also available. Requires external support by others.

Fan Discharge Attenuation (Optional)

Up to 10 dB(A) Reduction

This option allows for further sound reduction of the unit. The attenuator can be used with the standard fan or in combination with the Low Sound or Super Low Sound Fan option. The discharge attenuator is a factory-assembled straight-sided discharge hood designed to reduce overall discharge sound levels at full fan speed by 5 dB(A) to 10 dB(A), depending on specific unit selection and measurement location with a minimal impact to thermal performance. It is constructed of Z-725 galvanized steel as standard (options available for Type 304L stainless steel) and includes insulated walls and a low pressure drop baffling system that is acoustically lined with high density fiberglass. The discharge attenuator is self-supported by the unit and is shipped loose for field mounting. A heavy gauge, hot-dip galvanized steel fan guard covers the discharge attenuator to prevent debris from entering the attenuator.

Coil Connection Options

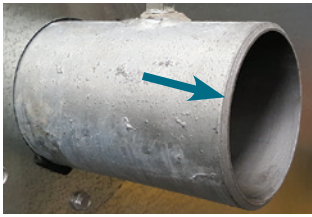

Beveled For Weld (BFW) Coil Connections

EVAPCO Closed Circuit Coolers are provided with Beveled For Weld (BFW) coil connections as standard. Beveled edges simplify field welding and allow welds to fully penetrate.



Optional Factory Mounted Crossover Piping

Some EVAPCO Closed Circuit Coolers are design for "series flow" coil operation where the coils inside of one cell are operated in series. These units are denoted by a "-Z" following the unit model number. These units require "crossover piping" from one coil to the other. Crossover piping is factory mounted as per standard for simplified field installation.

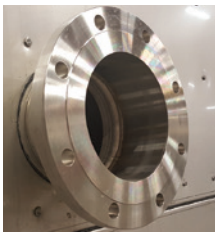

Optional Flanged Coil Connections

150# Raised Faced Flanged connections can be provided as an optional coil connection. The flanged coil connection allows for faster and easier field piping to a mating flanged connection. 300# flanged connections can be provided in some cases. Please see your local sales representative.

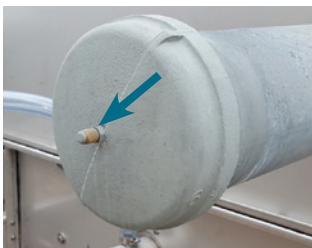

Optional Nitrogen Charged Coils

For projects requiring long term storage or ocean freight, coils can be nitrogen charged at the factory to prevent corrosion inside of the coil circuits.

NOTE: All coil connections are constructed from the same material as the coil.



Mr. GoodTower®

MR. GOODTOWER® SERVICES



SUCCESS STORY

Our Mr. GoodTower Service Center in Southwest France enhanced three cooling units with a specialized X-flow fill pack retrofit. This engineered kit, which includes integrated fill blocks with standalone eliminators and a robust, hot-dip galvanized structure, delivered a complete performance solution.

The upgrade successfully restored each unit to its originally designed capacity while introducing a maintenance-friendly design that keeps the basin fully accessible for cleaning and repairs.

This project stands as a testament to our commitment to delivering durable and efficient cooling solutions.

WORLD CLASS SERVICE



MR. GOODTOWER®

EVAPCO offers high quality parts, with a short lead time to extend the life of your equipment and provide years of trouble-free operation.

RVICE

Staying at the forefront of technology is just as important to us as it is you. In addition to developing sustainable solutions in our state-of-the-art research facility, we've also produced analysis tools to assist you in creating a holistic view of your cooling system.

Our powerful software can optimize your design process by **calculating annualized performance data** for your location and site-specific requirements. We can provide design engineers with a comprehensive range of **water and energy consumption** data to help identify the best cooling solution for any project. You can expect the final analysis to include:

- FREE COOLING POTENTIAL
- WATER CONSUMPTION
- COOLER POWER
- CHILLER POWER
- PUMP POWER
- AND MORE



LEADING THE INDUSTRY WITH



RESEARCH AND DEVELOPMENT

Tour the Wilson E. Bradley Research and Development Center, one of the largest and most advanced facilities of its kind.

With our tools, expertise, and global footprint, EVAPCO can help you reach your targets wherever your next data center may be.



TECHNOLOGY



WORLDWIDE MANUFACTURING FACILITIES



World Headquarters/
Research and
Development Center

EVAPCO Facilities

EVAPCO, Inc. — World Headquarters & Research / Development Center

P.O. Box 1300 • Westminster, MD 21158 USA
410.756.2600 • marketing@evapco.com • evapco.com

North America

- EVAPCO, Inc.**
World Headquarters
Westminster, MD USA
410.756.2600
marketing@evapco.com
- EVAPCO East**
Taneytown, MD USA
- EVAPCO East**
Key Building
Taneytown, MD USA
- EVAPCO Midwest**
Greenup, IL USA
217.923.3431
evapcomw@evapcomw.com
- Evapcold Manufacturing**
Greenup, IL USA
- EVAPCO Newton**
Newton, IL USA
618.783.3433
evapcomw@evapcomw.com
- EVAPCO West**
Madera, CA USA
559.673.2207
contact@evapcowest.com
- EVAPCO Alcoil, Inc.**
York, PA USA
717.347.7500
info@evapco-alcoil.com
- EVAPCO Iowa**
Lake View, IA USA
- EVAPCO Iowa**
Sales & Engineering
Medford, MN USA
507.446.8005
evapcomn@evapcomn.com
- EVAPCO LMP ULC**
Laval, Quebec, Canada
450.629.9864
info@evapcolmp.ca
- EVAPCO Select Technologies, Inc.**
Belmont, MI USA
844.785.9506
emarketing@evapcoselect.com
- Refrigeration Vessels & Systems Corporation**
Bryan, TX USA
979.778.0095
rvs@rvscorp.com
- Tower Components, Inc.**
Ramseur, NC USA
336.824.2102
mail@towercomponentsinc.com
- EvapTech, Inc.**
Edwardsville, KS USA
913.322.5165
marketing@evaptech.com
- EVAPCO Dry Cooling, Inc.**
Bridgewater, NJ USA
908.379.2665
info@evapcodc.com
- EVAPCO Dry Cooling, Inc.**
Littleton, CO USA
908.895.3236
info@evapcodc.com
- EVAPCO Power México S. de R.L. de C.V.**
Mexico City, Mexico
(52) 55.8421.9260
info@evapcodc.com

Asia Pacific

- EVAPCO Asia Pacific Headquarters**
Baoshan Industrial Zone Shanghai, P.R. China
(86) 21.6687.7786
marketing@evapcochina.com
- EVAPCO (Shanghai) Refrigeration Equipment Co., Ltd.**
Baoshan Industrial Zone, Shanghai, P.R. China
- EVAPCO (Beijing) Refrigeration Equipment Co., Ltd.**
Huairou District, Beijing, P.R. China
(86) 10.6166.7238
marketing@evapcochina.com
- EVAPCO Air Cooling Systems (Jiaxing) Company, Ltd.**
Jiaxing, Zhejiang P.R. China
(86) 573.8311.9379
info@evapcochina.com
- EVAPCO Australia (Pty.) Ltd.**
Riverstone, NSW, Australia
(61) 02.9627.3322
sales@evapco.com.au
- EvapTech (Shanghai) Cooling Tower Co., Ltd.**
Baoshan District, Shanghai, P.R. China
Tel: (86) 21.6478.0265
- EvapTech Asia Pacific Sdn. Bhd.**
Puchong, Selangor, Malaysia
(60) 3.8070.7255
marketing-ap@evaptech.com

Europe | Middle East | Africa

- EVAPCO Europe EMENA Headquarters**
Tongeren-Borgloon, Belgium
(32) 12.39.50.29
info@evapco.be
- EVAPCO Europe BV**
Tongeren-Borgloon, Belgium
- EVAPCO Europe, S.r.l.**
Milan, Italy
(39) 02.939.9041
evapcoeuropa@evapco.it
- EVAPCO Europe, S.r.l.**
Sondrio, Italy
- EVAPCO Europe A/S**
Aabybro, Denmark
(45) 9824.4999
info@evapco.dk
- EVAPCO Europe GmbH**
Meerbusch, Germany
(49) 2159.69560
info@evapco.de
- EVAPCO Middle East DMCC**
Dubai, United Arab Emirates
(971) 56.991.6584
info@evapco.ae
- Evap Egypt Engineering Industries Co.**
A licensed manufacturer of EVAPCO, Inc.
Nasr City, Cairo, Egypt
(20) 10.054.32198
evapco@tiba-group.com
- EVAPCO S.A. (Pty.) Ltd.**
A licensed manufacturer of EVAPCO, Inc.
Isando, South Africa
(27) 11.392.6630
evapco@evapco.co.za

South America

- EVAPCO Brasil**
Equipamentos Industriais Ltda.
Indaiatuba, São Paulo, Brazil
(55) 11.5681.2000
vendas@evapco.com.br
- FanTR Technology Resources**
Itu, São Paulo, Brazil
(55) 11.4025.1670
fantr@fantr.com